



***Bio-impedance monitoring in patients
with intradialytic hypertension***

Christelle Filmatter

Dissertation submitted in fulfilment of the requirements of the degree:

**MAGISTER TECHNOLOGIAE
CLINICAL TECHNOLOGY**

Department of Health Sciences
Faculty of Health and Environmental Sciences
Central University of Technology, Free State

Bloemfontein

5 August 2015

Supervisor : Dr Y Chothia, MMed (Int), FCP (SA)
Co-supervisor: Dr S Sebastian, MMed (Int), FCP (SA)
Prof E van den Heever-Kriek, PhD (UFS)

| DECLARATION OF OWN WORK

I, Christelle Filmalter, hereby declare that this research project submitted for the Magister Technologiae: Clinical Technology degree in the Faculty of Health and Environmental Sciences at the Central University of Technology, Free State, is my own independent work and has not yet previously been submitted to any institution by myself or any other person in the fulfilment of the requirements for the attainment of any qualification.

Christelle Filmalter

Date

| ACKNOWLEDGEMENTS

I want to sincerely thank the following:

- My Heavenly Dad for giving me this opportunity, the perseverance and the intellect to complete this research project.
- My best friend, love of my life, confidante and husband, Marcel, for absolutely everything you are to me.
- My family, especially my parents, Kobus and Lynette Coetzee, for all the encouragement, love, patience and support over the years.
- My phenomenal supervisors, Yazied, Sajith and Elmien. Your guidance was invaluable!
- Dr Justin Harvey, statistician at Stellenbosch University. You are brilliant!
- Fresenius Medical Care South Africa, specifically Brian, Hyran, Prof Charles, Cristine, Renche and Shelley. Thank you for investing all the hours of training, lectures and information over the years, also for sponsoring the equipment and allowing me to conduct the research during work hours.
- Central University of Technology, Free State for the research funding of the project.
- Mr Mack Gqirana, one of my first dialysis patients who passed away a long, long time ago. You were so special to me and taught me so much, not just about dialysis but also about life in general. This project is dedicated to you!

| SUMMARY

Intradialytic hypertension (IDH) is regarded as the paradoxical rise in blood pressure (BP) during chronic haemodialysis (HD). IDH increases morbidity and mortality. It is suggested that IDH may be due to subclinical fluid overload, but this has not been proven.

A multicentre, cross-sectional study was conducted at four HD units in the Western Cape. Cases of IDH were defined as a rise of ≥ 10 mmHg in systolic BP between pre-dialysis and post-dialysis in at least four out of six consecutive dialysis sessions. One hundred and ninety participants were included in the final analysis. Fluid status using whole body bio-impedance measurements (Body composition monitor, Fresenius Medical Care), hourly data regarding the HD procedure, pharmacological data and demographic data were collected.

There was a trend toward statistical significance regarding pre-dialysis fluid status when measured by whole body bio-impedance (mean overhydration (OH) pre-dialysis was 2.6L [95% confidence interval (CI) 1.7–3.4] in the IDH group versus (vs.) 1.8L [95% CI 1.4–2.1] in the control group; $p=0.06$). There was also a trend toward statistical significance in post-dialysis OH as measured by whole body bio-impedance (mean post-dialysis OH was 0.79L [95% CI -0.04–1.62] in the IDH groups vs. -0.17L [95% CI 0.52–0.18] in the control group; $p=0.06$). Pre-dialysis percentage extracellular water (ECW) did not achieve a significant result as measured by whole body bio-impedance (mean pre-dialysis percentage ECW was 12.3% [95% CI 8.3–16.3] vs. 9.6% [95% CI 7.8–11.5]; $p=0.12$) in IDH cases compared to controls. The post-dialysis results showed statistical significance with the IDH group's mean percentage ECW decreasing to 3.5% (95% CI -1.4–8.5) compared to the control group's mean percentage ECW of -1.4% post-dialysis (95% CI -3.7–0.8; $p=0.04$).

There was no statistically significant difference regarding mean total ultrafiltration (UF) volume (2 274ml vs. 2 462ml; $p=0.32$) in the IDH vs. the control group.

There was no statistically significant difference regarding mean age (57.1 years vs. 55.1 years; $p=0.42$), gender (males 53.7% vs. 59.5%; $p=0.46$), mean time-averaged sodium concentration (138.3mmol/L vs. 138.4mmol/L; $p=0.72$), mean dialysate calcium concentration (1.34mmol/L vs. 1.36mmol/L; $p=0.45$) or mode of dialysis ($p=0.66$) in the IDH group vs. the control group.

There is a statistically significant trend towards a difference in hydration status between patients who develop IDH and patients with stable BP on dialysis. The researcher hypothesises that subclinical fluid overload may be primarily responsible in the development of IDH.

Keywords: intradialytic hypertension, chronic haemodialysis, subclinical fluid overload, bio-impedance measurement

| LIST OF FIGURES

Figure 2.1	HD circuit	7
Figure 2.2	Movement of solutes according to molecular weight	8
Figure 2.3	Structure of a dialyser	9
Figure 2.4	Principles of HDF	10
Figure 2.5	Schematic diagram of post-dilution HDF	11
Figure 2.6	BP changes on dialysis explained with Frank Starling curve	20
Figure 2.7	Simplified schematic presentation of the changes in the ratio of sizes from the ICV to the ECV in changing sodium content in the ECV	25
Figure 3.1	Study layout	33
Figure 3.2	Body composition monitoring	37
Figure 3.3	Serum sodium measurement	38
Figure 4.1	Patient participation	45
Figure 4.2	Pre-dialysis and post-dialysis OH (L) in IDH group vs. control group	46
Figure 4.3	Pre-dialysis and post-dialysis percentage ECW in IDH group vs. control group	47
Figure 4.4	Mean hourly systolic BP (mmHg) during dialysis in IDH group vs. control group	50
Figure 4.5	Fluid removal on dialysis: Mean UF rate per hour over four hours (to the left) and total UF over four hours (to the right) for IDH group vs. control group	51
Figure 4.6	Mean total hours per week on dialysis for IDH group vs. control group	54

| LIST OF TABLES

Table 2.1	Definition of CKD by GFR – stages	4
Table 2.2	Prevalence of RRT in 1994 and 2012	6
Table 2.3	BCM output parameters	16
Table 2.4	Potential strategies for the treatment of IDH	31
Table 4.1	Pre-dialysis results: Baseline demographic results	48
Table 4.2	Pre-dialysis results: Clinical data	49
Table 4.3	Dialysis results: Clinical data	52
Table 4.4	Post-dialysis results: Clinical data	53

| LIST OF ABBREVIATIONS

BCM	body composition monitor
BMI	body mass index
BP	blood pressure
CI	confidence interval
CKD	chronic kidney disease
ECV	extracellular volume
ECW	extracellular water
ESRD	end stage renal disease
GFR	glomerular filtration rate
HD	haemodialysis
HDF	haemodiafiltration
ICV	intracellular volume
IDH	intradialytic hypertension
IDWG	interdialytic weight gain
KDIGO	Kidney Disease: Improving Global Outcomes
MAP	mean arterial pressure
OH	overhydration
OCM	online clearance monitor
PI	primary investigator
RAAS	renin-angiotensin-aldosterone system
rHuEpo	recombinant human erythropoietin
RRT	renal replacement therapy
TBW	total body water
UF	ultrafiltration (excess fluid removed over a time period)
vs.	versus

Units

cm	centimetre
Da	Dalton
hrs	hours
kg	kilogram
KHz	kilohertz
kg/m ²	kilogram per square metre
L	litre
ml	millilitre
ml/hr	millilitre per hour
ml/min	millilitre per minute
ml/min/1.73m ²	millilitre per minute per 1.73 square metre of body surface
mmHg	millimetres of mercury
mmol/L	millimol per litre
mS/cm	milli Siemens per centimetre

| TABLE OF CONTENTS

Declaration of own work	ii
Acknowledgements	iii
Summary	iv
List of figures	vi
List of tables	vii
List of abbreviations	viii

CHAPTER 1 INTRODUCTION **1**

1.1	Background	1
1.2	Aim of the study	3
1.3	Objectives of the study	3
	1.3.1 Primary objective	3
	1.3.2 Secondary objectives	3

CHAPTER 2 LITERATURE REVIEW **4**

2.1	Introduction	4
2.2	Haemodialysis	7
2.3	Haemodiafiltration	10
2.4	Interdialytic weight gain and body mass index	13
2.5	Bio-impedance monitoring	14
2.6	Blood pressure in haemodialysis	17

2.7	Factors associated with intradialytic hypertension	19
2.7.1	Subclinical volume overload	19
2.7.2	Activation of the sympathetic and renin-angiotensin-aldosterone systems	21
2.7.3	Endothelial cell dysfunction	22
2.7.4	Sodium gain during dialysis	24
2.7.5	Influence of dialysate calcium concentration	27
2.7.6	Use and route of administration of Erythropoietin-stimulating agents	28
2.7.7	Possible removal of antihypertensive agents during dialysis	29
2.8	Management of IDH	30

CHAPTER 3	METHODOLOGY	32
------------------	--------------------	-----------

3.1	Study location	32
3.2	Study design	32
3.3	Study layout	33
3.4	Study population	34
3.4.1	Number of subjects	34
3.4.2	Subject identification	34
3.4.3	Inclusion and exclusion criteria	35
3.4.3.1	Inclusion criteria	35
3.4.3.2	Exclusion criteria	35
3.5	Measurements	36
3.5.1	Blood pressure	36
3.5.2	Bio-impedance monitoring	36
3.5.3	Interdialytic weight gain and body mass index	37
3.5.4	Time-averaged serum sodium concentration on haemodialysis	38
3.6	Data collection	40
3.7	Statistical analysis	40

3.8	Ethical aspects and good clinical practice	41
3.8.1	Ethical clearance	41
3.8.2	Safety variables	41
3.8.2.1	Project and patient safety	41
3.8.2.2	Premature discontinuation of the study	41
3.8.2.3	Good clinical practice/quality assurance	41
3.8.3	Financial implications for the patient	42
3.8.4	Withdrawal criteria	42
3.8.5	Subject information and informed consent	42
3.8.6	Confidentiality	42
3.8.7	Conflict of interest	43

CHAPTER 4	RESULTS	44
------------------	----------------	-----------

4.1	Primary results	46
4.2	Pre-dialysis results	48
4.3	Dialysis results	50
4.4	Post-dialysis results	53

CHAPTER 5	DISCUSSION AND CONCLUSION	55
------------------	----------------------------------	-----------

5.1	Primary results	55
5.2	Pre-dialysis results	58
5.3	Dialysis results	59
5.4	Post-dialysis results	62
5.5	Limitations of the study	63
5.6	Recommendations	64
5.7	Conclusion	65

BIBLIOGRAPHY

66

APPENDICES

72

Appendix A – Standard operating protocol	72
Appendix B – Example of data collection sheet	74
Appendix C – Ethics approval	75
Appendix D – Clinical Trials.gov registration	82
Appendix E – World Congress of Nephrology 2015, abstract submission	86

1 | INTRODUCTION

1.1 Background

The current guideline for target blood pressure (BP) in patients with chronic kidney disease (CKD) according to the Kidney Disease: Improving Global Outcomes (KDIGO, 2012b) guidelines is 130/80mmHg (non-diabetics) and 140/90mmHg (diabetics).

Haemodynamic instability is a common complication in haemodialysis (HD); however, the focus is mostly on intradialytic *hypotension* rather than intradialytic *hypertension* (IDH), giving one a good idea of how the scales tip in terms of prevalence, awareness and general knowledge of IDH among the dialysis community.

Currently there is no standard definition of IDH. Definitions vary widely. Chazot *et al.* (2010) define IDH as systolic BP rise of ≥ 10 mmHg from start to finish of HD, rise in mean arterial pressure (MAP) during dialysis of 15mmHg or hypertension that appears resistant to ultrafiltration (UF) during or immediately after dialysis. Locatelli *et al.* (2010) suggest that the prevalence of IDH among HD patients varies between 5% and 15%. Simply put, IDH is the paradoxical rise in BP during or immediately after HD.

Inrig *et al.* (2007) and Inrig *et al.* (2009) showed that IDH increased the risk of hospitalisation and death, as reported in the Crit-Line Intradialytic Monitoring Benefit study and the United States Renal Data System HD study.

The pathogenesis of IDH is unclear. A number of factors have been implicated and could be responsible, acting collectively or separately.

Factors that might have an impact include subclinical volume overload, as indicated by Agarwal *et al.* (2010), activation of the sympathetic system and the renin-angiotensin-aldosterone system (RAAS), endothelial cell dysfunction, sodium gain during dialysis, use and route of administration of erythropoietin-stimulating agents and possible removal of antihypertensive agents during dialysis.

The literature suggests that the management of IDH relies heavily on fluid dynamics and control of sodium in terms of diet as well as interdialytic management. Contradicting this statement, though, were the findings published by Van Buren *et al.* (2011); there was no difference in interdialytic weight gain (IDWG) between the IDH group and the control group in their study.

This poses the following question: Is there a difference in hydration status between patients who develop IDH compared to patients with stable BP on dialysis?

1.2 Aim of the study

The aim of this study was to determine whether patients with IDH were subclinically fluid overloaded.

1.3 Objectives of the study

1.3.1 Primary objective

To compare overhydration (OH) (measured in L) between patients with IDH and the control group.

1.3.2 Secondary objectives

To determine the association/correlation between IDH and the following potential risk factors:

- IDWG
- Body mass index (BMI)
- Time-averaged serum sodium concentration on HD
- Dialysate calcium concentrations
- Dialysis modality

2 | LITERATURE REVIEW

2.1 Introduction

Chronic kidney disease is defined as a progressive, irreversible loss of renal function over a time period of more than three months (Levy *et al.*, 2010). The KDIGO guidelines published in 2012 (KDIGO, 2012a) have developed a classification of CKD based on glomerular filtration rate (GFR) measured in ml/min/1.73m² (see Table 2.1).

Table 2.1: Definition of CKD by GFR – stages

Stage	GFR description	GFR (ml/min/1.73m ²)
G1	Normal or high	≥90
G2	Mildly decreased	60–89
G3a	Mildly to moderately decreased	45–59
G3b	Moderately to severely decreased	30–44
G4	Severely decreased	15–29
G5	Kidney failure	<15

(Adapted from KDIGO, 2012a)

The aim in terms of managing patients with CKD is predominantly to slow the rate of progression of renal damage. This can be achieved by diagnosis and treatment of reversible causes.

The focus would be on control of BP, glycaemia, dyslipidaemia, anaemia and hyperparathyroidism caused by renal damage, as well as prevention of symptoms, mainly those due to fluid overload and uraemia. These symptoms can present as early as Stage G3a (see Table 2.1). By reducing each of these markers, the rate of progression of renal damage and cardiovascular risk can be minimised (Levy *et al.*, 2010).

The KDIGO guidelines (2012a) recommend that a patient with CKD be referred to a nephrologist and that a multidisciplinary renal team be prepared, both mentally and physically, for renal replacement therapy (RRT) when

- there is an abrupt sustained decline in GFR;
- a patient's GFR $<30\text{ml}/\text{min}/1.73\text{m}^2$ (stages G4 and G5);
- there is a consistent finding of significant albuminuria and/or urinary red cell casts;
- a patient presents with a combination of CKD and hypertension irrespective of treatment with four or more antihypertensive agents;
- a patient presents with persistent abnormalities of serum potassium;
- there is recurrent or extensive nephrolithiasis (calculi in the kidneys); and
- a patient has a hereditary kidney disease.

Renal replacement therapy should be initiated when one or more of the following are present:

- Symptoms or signs attributed to kidney failure.
- Inability to control fluid volume status, resulting in OH and subsequent inability to control BP.
- A progressive deterioration in nutritional status irrespective of dietary intervention.
- Cognitive impairment due to uraemia.

These symptoms often occur in the GFR range between $5\text{ml}/\text{min}/1.73\text{m}^2$ and $10\text{ml}/\text{min}/1.73\text{m}^2$ in Stage G5 and are termed 'end stage renal disease' (ESRD) (KDIGO, 2012a).

Treatment options for RRT include renal transplantation, HD, peritoneal dialysis or conservative management.

The number of ESRD patients receiving RRT in South Africa was 8559 at the end of 2012, as shown in Table 2.2. This was reported in the first *South African Renal Registry Annual Report 2012* (Davids *et al.*, 2014).

Table 2.2: Prevalence of RRT in 1994 and 2012

	1994	2012
Population in millions	40.4	52.3
ESRD patients on treatment	2843	8559
Treatment rate per million of population	70	164

(Adapted from Davids *et al.*, 2014)

The purpose of this IDH study was to evaluate patients on HD; therefore, the principles of the various types of HD will be discussed in this chapter.

2.2 Haemodialysis

Haemodialysis is an extracorporeal blood purification treatment for patients with CKD in Stage G5. Blood is obtained through vascular access to the patient and pumped via a blood pump on the HD machine through an artificial kidney called a dialyser, as shown in Figure 2.1.

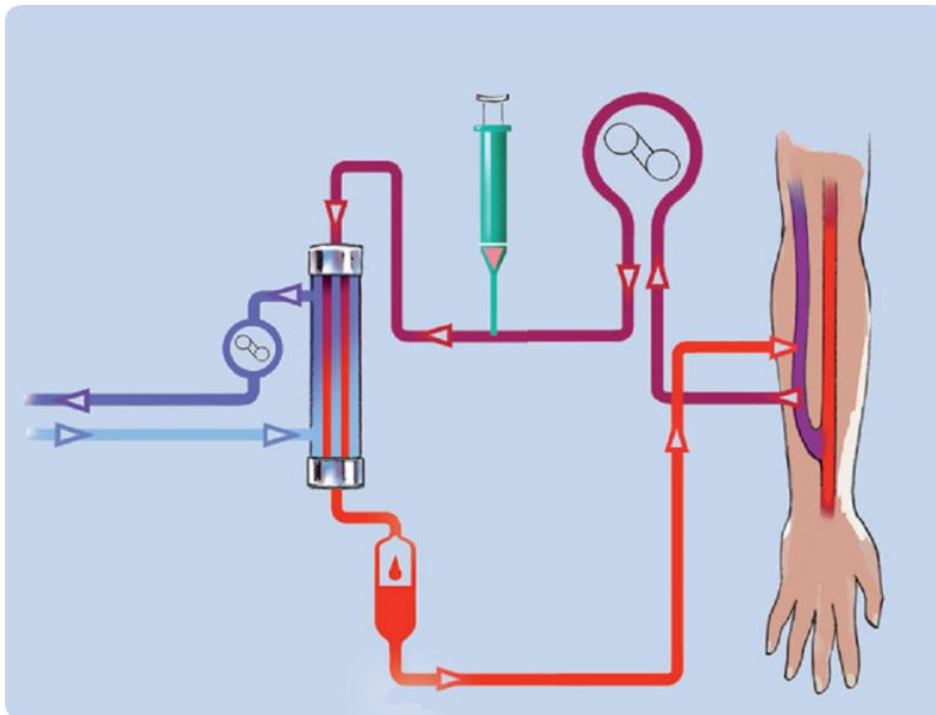

Figure 2.1: HD circuit

(Fresenius Medical Care Deutschland GmbH, 2012)

The dialyser consists of hollow fibres called capillaries, with variable-sized pores in the walls of the capillaries, giving it semi-permeable characteristics. Certain solutes, depending on molecular weight, are allowed to move from the blood to the outside of the capillaries where the dialysate compartment is situated, as depicted in Figure 2.2.

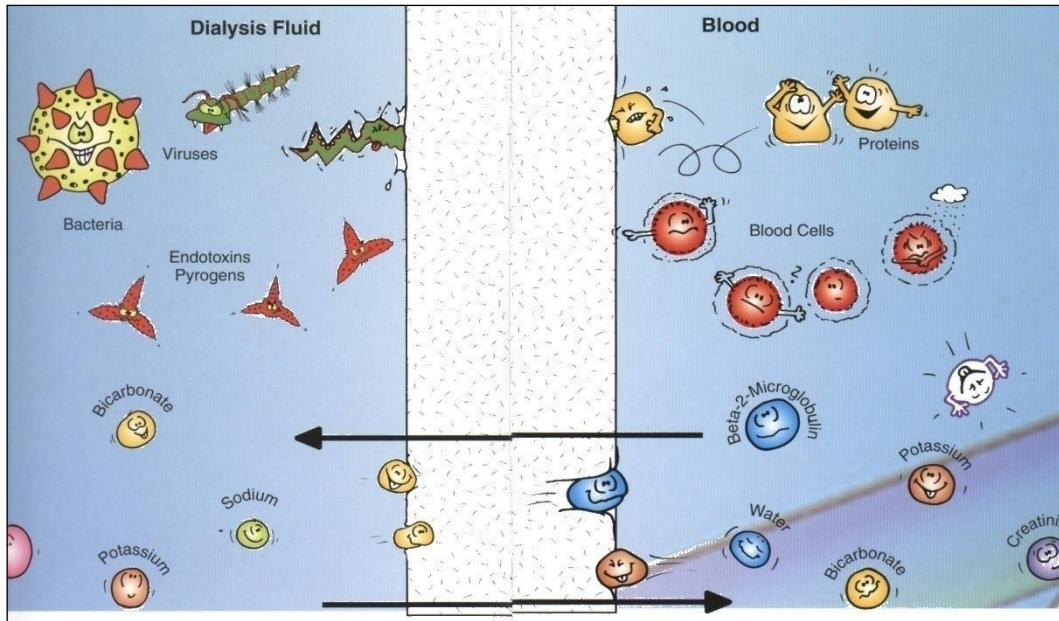

Figure 2.2: Movement of solutes according to molecular weight

(Fresenius Medical Care Deutschland GmbH, 2007)

A low electrolyte solution, dialysate, is pumped through the dialyser via a dialysate pump in the HD machine in a direction counter to that of the blood flow, as seen in Figure 2.3.

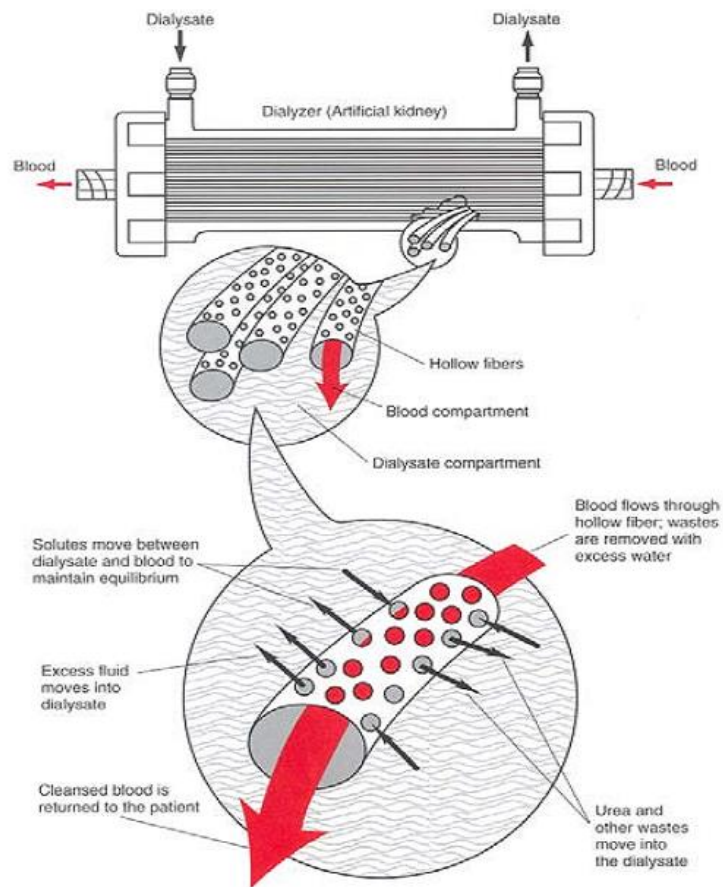

Figure 2.3: Structure of a dialyser

(Fresenius Medical Care Deutschland GmbH, 2007)

Basic principles in HD facilitating purification of the blood are diffusion, osmosis and UF. A concentration gradient between the high concentration of the blood compared to the low concentration of the dialysate permits diffusion of excess electrolytes to take place until equilibrium is reached. Small molecular weight electrolytes (e.g. urea, creatinine and potassium) are targeted by diffusion. UF is the removal of excess fluid from the blood. Osmosis and UF are facilitated by creating a hydrostatic pressure in the capillaries, namely transmembrane pressure.

Modern HD machines have volumetric control systems whereby the actual UF rate (ml/hr) is measured directly by quantifying the volume of dialysate being pumped into and out of the dialyser (see Figure 2.3). The UF rate can be adjusted by altering the flow rates on the HD machine's display (Levy *et al.*, 2010).

2.3 Haemodiafiltration

Continuous improvement of the efficiency of HD treatment modalities was necessitated by the unacceptably high morbidity and mortality rates among HD patients. Clearance of especially medium-sized and large molecules is not effectively facilitated by conventional HD (Maduell *et al.*, 2013). As a result, haemodiafiltration (HDF) was developed to target improved clearance profiles for a broader range of small, medium-sized and large molecules.

Basic principles in HDF facilitating purification of the blood are diffusion, osmosis, UF and the added benefit of convection. Convection is solute drag facilitated by the movement of fluid over the dialyser membrane, as depicted in Figure 2.4.



Figure 2.4: Principles of HDF

(Fresenius Medical Care Deutschland GmbH, 2007)

The fluid to be utilised for convection in the dialyser does not originate from the patient but is rather manufactured by the dialysis machine online. This fluid is called 'substitution fluid' and is a physiological fluid prepared online from dialysate.

During the dialysis treatment, the substitution fluid is administered via a volumetric pump in the dialysis machine into the extracorporeal circuit.

Pre-dilution HDF occurs when the fluid is substituted before the dialyser, and post-dilution HDF occurs when the fluid is substituted after the dialyser in the extracorporeal circuit. Post-dilution HDF is depicted in Figure 2.5. The exact amount of substituted fluid administered into the patient's blood (not to exceed 30% of blood flow rate) is subsequently removed in the dialyser via the volumetric system of the machine. This causes a large fluid shift from the patient's blood across the semi-permeable membrane of the dialyser into the dialysate compartment, dragging and clearing especially medium-sized and large molecules via convection. In combination with conventional diffusion and UF, the clearance for online HDF has been proven to be much more efficient than for HD (Canaud *et al.*, 2000).

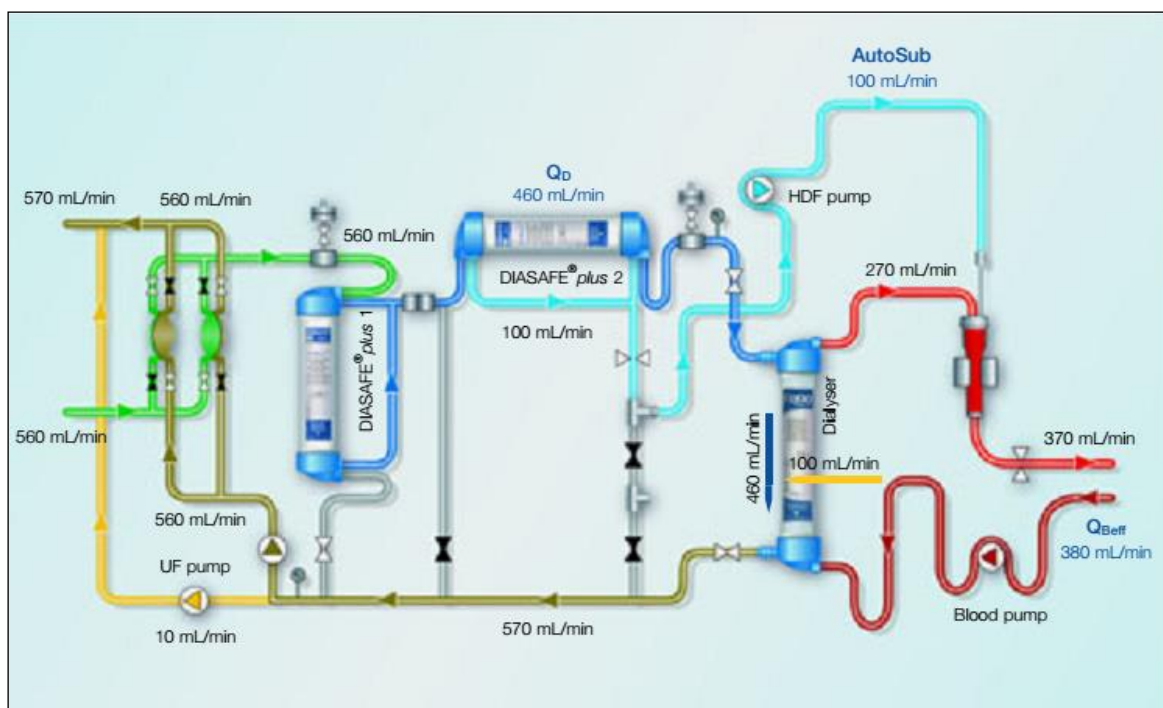

Figure 2.5: Schematic diagram of post-dilution HDF

(Fresenius Medical Care Deutschland GmbH, 2007)

Maduell *et al.* (2013) reported on a large study conducted in Spain, involving 906 chronic HD patients. Four hundred and fifty patients continued with conventional HD, and 456 patients were switched to high-efficiency post-dilution HDF. The follow-up period was 36 months. The primary outcome was all-cause mortality, and secondary outcomes included cardiovascular mortality, all-cause hospitalisation, treatment tolerability and laboratory data. The results were significant. Compared with patients who continued on conventional HD, those assigned to HDF had a 30% lower risk of all-cause mortality ($p=0.01$), a 33% lower risk of cardiovascular mortality ($p=0.06$) and a 55% lower risk of infection-related mortality ($p=0.03$), (Maduell *et al.*, 2013). High-efficiency online HDF is now being recognised in the dialysis industry as an advanced HD treatment modality that improves patient outcomes.

2.4 Interdialytic weight gain and body mass index

Interdialytic weight gain is calculated by measuring a patient's weight/fluid gain between two HD sessions. Non-adherence to fluid restrictions results in excess weight gain between two dialysis sessions as the majority of HD patients have minimal residual renal function and are anuric. Patients who still produce large volumes of urine can adhere to less stringent fluid restrictions. Body weight biases the amount of IDWG and intradialytic weight loss (Denhaerynck *et al.*, 2007). Compared with a lighter patient, a heavier patient will tolerate a larger percentage of body weight gained as fluid interdialytically. Denhaerynck *et al.* (2007) used a cut off value defined by Leggat *et al.* (1998) who defined a patient as non-adherent to fluid restrictions when the patient's IDWG exceeded 5.7% of the patient's dry weight (weight when patient is euvolaemic). The precise clinical relevance of this cut off value remains controversial. However, Leggat *et al.* (1998) further reported that patients who had greater IDWG than 5.7% of their dry weight had a 35% higher risk of death ($p < 0.001$). The authors also commented that patients who had a good nutritional status with a BMI $> 23.0 \text{ kg/m}^2$ (as published by the European Best Practice Guidelines, 2007) reflected a somewhat higher IDWG compared to patients who had a BMI $< 23.0 \text{ kg/m}^2$.

This is a contradictory statement, though, simply because a BMI $> 23.0 \text{ kg/m}^2$ for dialysis patients is considered as being conducive to survival. A BMI $> 23.0 \text{ kg/m}^2$ reflects a healthy lifestyle and good quality of life.

2.5 Bio-impedance monitoring

Fluid overload is a common condition among patients on dialysis and one of the major causes of mortality, as explained in the previous section. Achieving optimal fluid balance (euvolaemia) remains a major clinical challenge in dialysis units, and assessment of fluid status based on subjective indicators, for example pedal oedema, pulmonary oedema, hypertension or cardiac dysfunction, has been a limiting factor.

Levin *et al.* (1996) reported in their study published in the *American Journal of Kidney Disease* that improving the treatment of hypertension and correction of fluid balance has the potential to limit the development of left ventricular hypertrophy, thus increasing life expectancy.

The need for alternative methods of accurate fluid assessment arose, and bio-impedance spectroscopy was one of the techniques investigated. Moissl *et al.* (2006) reported that bio-impedance measurement might be an appropriate method for body fluid volume determination. It also proved to be accurate over a wide range of body compositions in different states of health and disease, which made it an ideal technique for CKD patients on dialysis.

The Body composition monitor (BCM) from Fresenius Medical Care Deutschland GmbH was evaluated by Covic *et al.* (2009). The purpose of the study was to present epidemiological body composition data in dialysis patients to eventually optimise fluid balance and patient outcomes. The researchers recruited 150 peritoneal dialysis patients to participate, and the results showed that 55% of the patients were overhydrated. The OH could not be predicted by their BP or body weight. In contrast, almost half of the OH patients (47%) had a systolic BP below 140mmHg. The conclusion was that the BCM measurement provided essential information to identify patients at risk, thus supporting clinicians in optimising dialysis therapy and patient outcomes.

The BCM used in the current study is based on a non-invasive and accurate method that is easy to apply, and results are obtained within minutes.

It employs bio-impedance spectroscopy techniques that measure at 50 different frequencies over a range from 5kHz to 1000kHz to determine the electrical resistances of the total body water (TBW) and the extracellular water (ECW). While a high-frequency current passes through the TBW, a low-frequency current cannot penetrate cell membranes and thus flows exclusively through the ECW.

The BCM quantifies fluid status in terms of OH as well as the value for TBW that is used in dialysis quality measurements. It also assesses body composition in terms of lean tissue mass and adipose tissue mass. Based on the amount of OH (measured in L), the BCM can calculate accurately what the patient's dry weight is. Dry weight can be described as the state during which the patient is in optimal fluid balance (euvolaemic).

The BCM's output parameters (see Table 2.3) have been validated against the gold standard reference methods in various studies involving more than 500 patients and healthy controls (Moissl *et al.*, 2006; Wabel *et al.*, 2009).

Table 2.3: BCM output parameters

Key parameters	Unit
Overhydration (pre-/post-dialytic)	L
Lean tissue index	Kg/m ²
Fat tissue index	Kg/m ²
Total body water (urea distribution volume)	L
Extracellular water	L
Intracellular water	L
ECW/ICW	-
Lean tissue mass	Kg and %
Fat mass	Kg
Adipose tissue mass	Kg and %
Body cell mass	Kg

(Adapted from BCM product folder, Fresenius Medical Care Deutschland GmbH, 2007)

2.6 Blood pressure in haemodialysis

Blood pressure is generated when the heart contracts against the resistance of the blood vessels. Typically hypertension results from an increase in systemic vascular resistance with normal cardiac output. However, with intermittently hypertensive patients (e.g. dialysis patients), increased cardiac output may be the only haemodynamic disturbance. Over time, cardiac output 'normalises' and systemic vascular resistance increases due to various factors to sustain the hypertension.

The relationship between BP and clinical outcome in HD patients has always been a very complex issue; furthermore, hypertension is probably the most important complication of renal disease. However, in the majority of chronic HD patients, BP is supposed to decline when UF takes place during a dialysis session (excess fluid is removed over a time period). Unfortunately, there is a group of HD patients, presumed to be between 10% and 15% of the dialysis population, as reported by Agarwal *et al.* (2010), who's BP increases rather than decreases during dialysis. This phenomenon is called IDH. Chazot *et al.* (2010) define it as systolic BP rises of ≥ 10 mmHg from start to finish of HD, rise in MAP during dialysis > 15 mmHg or hypertension that appears resistant to UF during or immediately after dialysis.

Sustained hypertension is one of the main culprits causing left ventricular hypertrophy in chronic renal failure patients, increasing the risk of cardiovascular death greatly (Levy *et al.*, 2010). As cited in the introduction, Inrig *et al.* (2007) showed that IDH increased the risk of hospitalisation and death, as reported in the Crit-Line Intradialytic Monitoring Benefit study.

Analysis of 1748 incident HD patients in the United States Renal Data System study found that the adjusted hazard for death at two years for HD patients was 6% per 10mmHg rise in systolic BP (Inrig *et al.*, 2009).

Hypertension can be caused by various factors, and especially where IDH is concerned, the pathogenesis of it is still unclear. However, several studies have found that volume overload, be it clinical or subclinical, drives this process (Cirit *et al.*, 1995; Gunal *et al.*, 2002; Agarwal *et al.*, 2010). These studies have also reported patients who presented with 'malignant' hypertension unresponsive to antihypertensive drugs but who became normotensive after an increasing rate of UF.

A number of factors have been implicated in causing IDH and could be responsible as a collective or acting separately. Factors that might have an impact include subclinical volume overload, as indicated by Agarwal *et al.* (2010), activation of the sympathetic system and the RAAS, endothelial cell dysfunction, sodium gain during dialysis, use and route of administration of erythropoietin-stimulating agents and possible removal of antihypertensive agents during dialysis (Fourtounas, 2010; Locatelli *et al.*, 2010).

2.7 Factors associated with intradialytic hypertension

2.7.1 Subclinical volume overload

Hypervolaemia (volume expansion) due to excessive intradialytic fluid gain is one of the most important factors that causes higher levels of BP in anuric patients with CKD. This has been known for quite some time and has resulted in the concept of 'dry weight' in ESRD patients who are dependent on dialysis for volume control. Dry weight is defined as the lowest weight that a patient can tolerate without the development of symptoms or hypotension. According to the Kidney Disease Outcomes Quality Initiative guidelines published in 2005 (Levy *et al.*, 2010), UF should be optimised in such a way that patients are normotensive and euvolaemic post-dialysis, in other words a BP of $\pm 130/80$ mmHg and normal fluid balance (i.e. dry weight). Agarwal *et al.* (2010) showed very clearly in the *post hoc* analysis of the Dry Weight Reduction in Hypertensive Haemodialysis Patients trial conducted in 2010 how UF and thus bringing patients closer to their dry weights could manipulate especially systolic BP and reported at baseline, intradialytic systolic and diastolic BP drop at a rate of 3%/h. The authors concluded that intradialytic BP changes appeared to be associated with change in dry weight among HD patients.

Cirit *et al.* (1995) showed a similar result; the patients whom they investigated all had marked cardiac dilatation, but most did not present with signs of oedema associated with hypervolaemia. They were treated with repeated intense UF. After a variable time period, all the patients became normotensive without additional medication. The authors concluded that a paradoxical rise in BP with UF usually occurred in the presence of hypervolaemia but also stated that the explanation for this occurrence remained speculative.

Gunal *et al.* (2002) suggested that the Frank–Starling law can explain the association of fluid overload and IDH. The authors reported patients who presented with low cardiac ejection fractions subsequent to serious deterioration in cardiac function, possibly resulting from chronic hypervolaemia and who were on the right down slope side of the curve (see Figure 2.6).

Following UF in the initial stage of dialysis, cardiac preload was moderately reduced and the ejection fraction was increased. Patients moved to the flat region of the curve, and the blood pressure reached a peak. Subsequently, with continuing UF, euvoemia was obtained; patients moved to the left ascending slope side of the curve and became normotensive at the end of dialysis (see Figure 2.6).

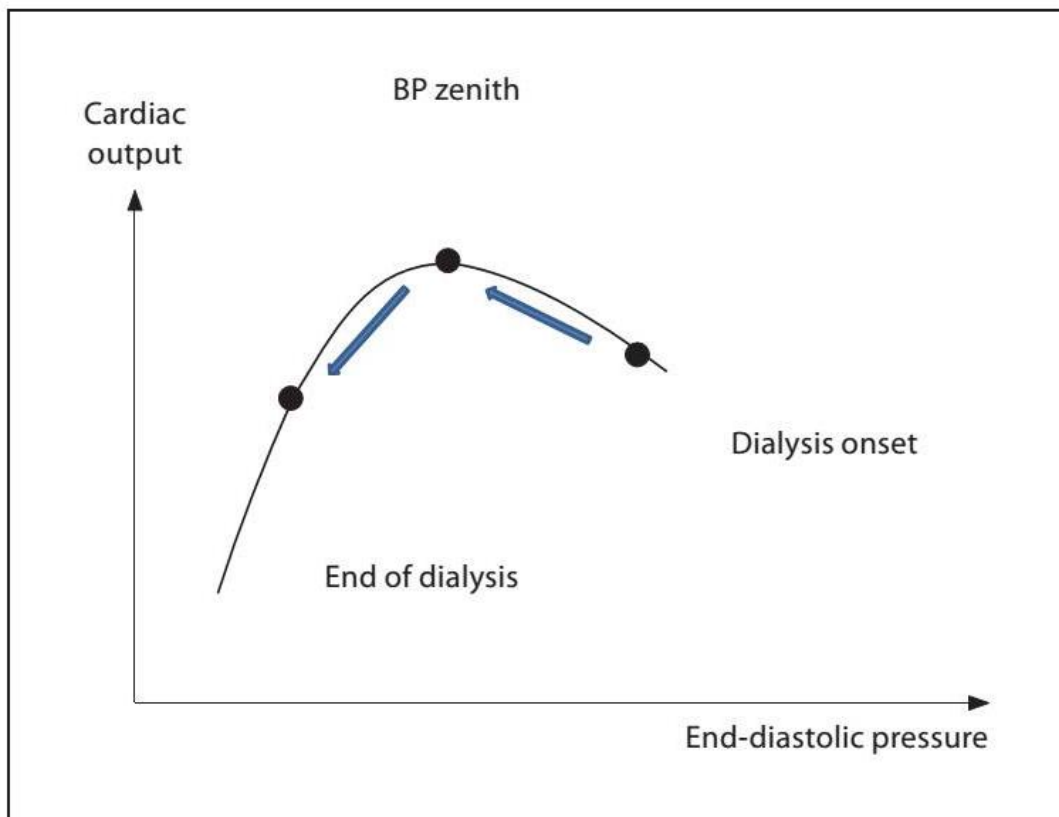

Figure 2.6: BP changes on dialysis explained by the Frank Starling curve

(Adapted from Gunal *et al.*, 2002)

2.7.2 Activation of the sympathetic and renin-angiotensin-aldosterone systems

Another option to be considered as the cause of IDH is the activation of the sympathetic system (catecholamine response) and/or activation of the RAAS due to UF-induced hypovolaemia causing excessive activation of these systems (possibly taking off too large a volume of fluid in too short a space of time, e.g. >500ml/hour. This can cause a sudden rise in systemic vascular resistance and an increase in BP.

A completely opposite hypothesis to that proposed in the previous paragraph also exists. Chou *et al.* (2006) analysed the biochemical and hormonal status in 30 HD patients presenting with IDH and compared it to a control group of 30 patients without IDH. No significant differences were found between the two groups except for the MAP level, which was, as expected, higher in the IDH group. Contrary to the initial hypothesis, the plasma renin and norepinephrine increased in the control group but not in the IDH group. The absence of evidence of increased sympathetic activity in IDH patients remains to be confirmed by further studies utilising other methods exploring the sympathetic system.

2.7.3 Endothelial cell dysfunction

Endothelial cells constitute the thin layer that lines the interior surface of blood and lymphatic vessels. The endothelial monolayer is able to transduce both mechanical and chemical signals into appropriate changes (vasodilation/vasoconstriction) in vascular smooth muscle tone under normal circumstances. Fluid volume changes during HD and physical and hormonal triggers result in the production of substances involved in BP control in endothelial cells.

Three of the most important vasoactive substances are 1) nitric oxide, a powerful smooth muscle vasodilator and also an important signalling molecule; 2) asymmetric dimethylarginine, an endogenous inhibitor of nitric oxide synthesis; and 3) endothelin1, a vasoconstrictor. These substances have important effects on sympathetic activity, peripheral vasoconstriction and BP control. Inrig *et al.* (2011) reported that endothelial dysfunction (indirectly because of imbalances of nitric oxide and endothelin1) could cause considerable changes in BP during HD, including IDH. Fifty patients were studied, 25 without IDH (control group) and 25 with IDH.

The results showed that endothelial cell function was markedly impaired in the IDH group.

Chou *et al.* (2006) found differences in changes in nitric oxide and endothelin1 levels between control patients and individuals prone to IDH. At the end of dialysis, patients with IDH showed a significant increase in endothelin1 levels and a significant decrease in nitric oxide: endothelin1 ratio compared with control patients. This might give an indication that the interaction among nitric oxide, asymmetric dimethylarginine and endothelin1 has a significant role in controlling BP. Teng *et al.* (2014) reported a similar result as Chou *et al.* (2006). They studied 34 patients; 17 control cases were age matched and sex matched to 17 IDH cases. Pre-dialysis there was no significant difference in endothelin1 levels or nitric oxide: endothelin1 ratio between the two groups. However, Teng *et al.* (2014) found a significant increase in endothelin1 levels ($p < 0.05$) post-dialysis in the IDH patients compared to the control group. There was also a significant decrease ($p < 0.05$) in nitric oxide: endothelin1 ratio in the IDH group compared with control patients post-dialysis.

In support of the endothelial cell dysfunction hypothesis, Inrig *et al.* (2011) performed a 12-week pilot study on 25 HD patients in Dallas, Texas. Carvedilol (non-selective beta blocker/alpha-1 blocker indicated in the treatment of mild to severe congestive heart failure) has been shown to improve endothelial cell function; *in vivo* and *in vitro* studies also indicated that it blocked endothelin1 release. Each patient acted as his or her own control. The results of this study showed no significant change in endothelial progenitor cells, endothelin1 or asymmetric dimethylarginine levels. Interestingly, there was no change in pre-dialysis systolic BP over the 12 weeks, but the post-dialysis BP and, most importantly, the frequency of IDH decreased significantly on Carvedilol ($p < 0.001$). Inrig *et al.* (2011) concluded that to improve endothelial cell function and achieve a subsequent lower incidence of IDH, Carvedilol should be prescribed to HD patients experiencing IDH as well as interdialytic hypertension. The authors suggested further investigation in the form of randomised controlled trials to confirm their findings.

2.7.4 Sodium gain during dialysis

Fresenius Medical Care Deutschland GmbH (2012) compiled an extremely descriptive compendium, *Sodium and UF profiles in dialysis: Structure, application and effect*, in 2004, explaining the concept behind sodium and fluid shifts on a cellular level.

Sodium is the most important osmotic agent in the extracellular volume (ECV). The sodium content defines the size of the ECV. The higher the sodium content, the higher the ECV, and vice versa. Take into consideration that the ECV correlates with the intracellular volume (ICV) and that the volume ratio of ECV to ICV is approximately 30:70. Also keep in mind that the ECV can be divided further into two compartments: the ICV (referred to subsequently when discussing sodium gain during HD) and the interstitial volume. Sodium concentrations in the ECV are 142mmol/L–145mmol/L. In the ICV, sodium plays a much smaller role with a concentration of only 10mmol/L.

Under normal physiological conditions, a state of osmotic balance is established by the distribution of the TBW between the compartments (as shown in Figure 2.7a). In case of a change in the osmotic balance in one of the compartments due to a change in the concentration of, for example, sodium, water crosses the cell membrane between the ICV and ECV until the osmotic balance between the ECV and ICV is restored again. Figure 2.7b shows, for instance, that when sodium concentration increases in the ECV, the fluid shifts from the ICV to the ECV; the ECV increases and the ICV decreases. When sodium concentration in the ECV decreases, fluid shifts from the ECV to the ICV, followed by an increase in the ICV and a decrease in the ECV (see Figure 2.7c).

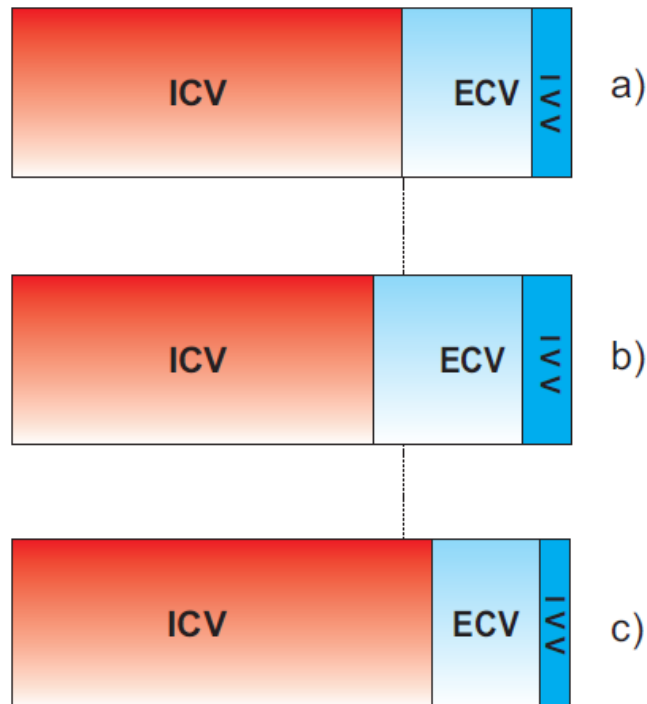

ECV – Extracellular volume

ICV – Intracellular volume

IVV – Intravascular volume

Figure 2.7: Simplified schematic presentation of the changes in the ratio of sizes from the ICV to the ECV in changing sodium content in the ECV

(Fresenius Medical Care Deutschland GmbH, 2004)

Sodium promotes the fluid transport between the compartments. It is the driving force behind water transport and distribution between the ECV and ICV.

According to the Kidney Disease Outcomes Quality Initiative guidelines published in 2005, a positive sodium balance is the main mechanism of extracellular fluid overload and hypertension in dialysis patients (NKF KDOQI, 2005). The sodium balance becomes positive when dietary sodium intake exceeds sodium removal during dialysis, and a low-sodium diet should be advised for the majority of dialysis patients.

The sodium balance can also become positive when the patient's body composition changes due to progressive fat and lean body mass loss without dry weight prescription adjustment.

As noted by Locatelli *et al.* (2004), although a high sodium concentration in dialysate has been used to improve dialysis tolerance, it increases sodium diffusion and exposes the patient to a high intradialytic sodium load, which in turn can result in increased BP. Locatelli *et al.* (2010) elaborates on this further in a review article; if the sodium concentration in the dialysate is higher than the patient's pre-dialysis plasma sodium concentration, sodium is given to the patient via diffusion so that the difference in concentrations equalises. In this case, the diffusive sodium transport to the patient counteracts the convective sodium removal that occurs as a result of UF. This phenomenon, however, causes insufficient net sodium removal, which can result in the development of refractory hypertension and IDH.

In addition, dialysate with a high sodium concentration or manipulation of the dialysate via a high sodium profile (in relation to the patient's plasma sodium) can trigger an intense sense of thirst, resulting in high water intake during the interdialytic period. Subsequently, this can trigger various complications (including cramps and hypotension) during the next dialysis session when the excess fluid needs to be removed with high UF rates. This can develop into a snowball effect, as elevated sodium concentration dialysate or 0.9% saline can be utilised to counteract the hypotension, again resulting in a sodium gain, often resulting in IDH, cardiac failure and pulmonary oedema.

2.7.5 Influence of dialysate calcium concentration

The KDIGO guidelines published in 2009 suggested that target serum calcium levels for CKD patients on dialysis should be 2.2mmol/L–2.5mmol/L. The guidelines placed strong emphasis on avoiding hypercalcaemic episodes, for various reasons.

Calcium concentrations vary in dialysis solutions from 1.25mmol/L to 1.75mmol/L, depending on the product and manufacturer. The dialysate calcium level tends to equilibrate with the ionised fraction of the serum calcium (which equates to approximately 60% of the body's total calcium; the remaining 40% is bound to proteins and is therefore not dialysable).

When prescribing the concentration of calcium-containing dialysate, besides the very important mineral and bone metabolism issues that might arise from subsequent abnormal serum calcium levels, one needs to consider the effect of dialysate calcium level on systemic BP. It has been shown that the use of a low-calcium dialysate (1.25mmol/L) is associated with a mild but significant decline in mean BP during dialysis (Sam *et al.*, 2006). The decline in BP is mediated by a decrease in cardiac contractility. There is no change in systemic vascular resistance as initially speculated, though, as reported by Locatelli *et al.* (2004). It has been speculated that the opposite could be true: a high calcium dialysate (1.75mmol/L) can increase cardiac contractility, with a subsequent increase in mean BP while on dialysis.

However, Chou *et al.* (2006) found no calcium variations between the IDH and control groups in their study. They reported that ionic variations were often nonspecific and similar in the great majority of dialysis patients with or without IDH.

2.7.6 Use and route of administration of erythropoietin-stimulating agents

Erythropoietin is a hormone that controls erythropoiesis or red blood cell production. Erythropoietin is a protein-signalling molecule for red blood cell precursors in the bone marrow. It is primarily produced by interstitial fibroblasts in healthy kidneys.

Recombinant human erythropoietin (rHuEpo) corrects the anaemia of ESRD. The dosage and frequency of rHuEpo prescribed to CKD patients depend on the severity of their anaemia, and rHuEpo is administered via an injection (subcutaneously or intravascular). However, intravenous administration has been associated with elevations in BP in dialysis patients and, interestingly, also with elevations in endothelin1 levels (Inrig *et al.*, 2011).

Buckner *et al.* (1990) reported that hypertension was observed as an adverse effect of increasing haematocrit. In their study, 44 out of 63 patients (70%) treated with rHuEpo had an increase in MAP greater than 10mmHg or required new or additional hypertensive medications.

Interestingly, factors not associated with hypertension included the rate of rise of the haematocrit, the net rise in haematocrit, age, sex, the number of years on dialysis, the presence or absence of kidneys, smoking and the presence of pre-treatment hypertension. The authors' conclusion (Buckner *et al.*, 1990) was that increased blood viscosity or haemoconcentration-induced vasoconstriction (caused by erythropoietin treatment) could increase MAP, resulting in hypertension.

2.7.7 Possible removal of antihypertensive agents during dialysis

As explained by Chazot *et al.* (2010) and Locatelli *et al.* (2010) in their review articles, specific drugs, including some antihypertensive medications, are removed by the dialysis procedure (relating to their molecular weight being small enough to move via diffusion/convection through the dialyser pores).

The effect of drug removal on the occurrence of IDH has not been studied specifically. Removal of antihypertensive medications could lead to IDH. Although calcium channel blockers are not removed by the dialysis procedure, several angiotensin-converting enzyme inhibitors (captopril, enalapril, lisinopril, perindopril and ramipril) and betablockers (atenolol, metoprolol and nadolol) are significantly removed by dialysis, whereas others are not (fosinopril, propranolol, pindolol, esmolol, bisoprolol, carvedilol and acebutalol). Vasodilating agents are usually removed (minoxidil, diazoxide and nitroprusside), except for hydralazine and prazosin.

In conclusion, an awareness of which drugs are extensively removed by dialysis is very important so that therapies can be adjusted if necessary in patients who develop IDH.

2.8 Management of intradialytic hypertension

There have been no randomised trials regarding management of IDH, placing a heavy reliance on expert opinions.

Management of IDH is directed at all of the aforementioned pathogenic mechanisms, but normalising volume overload and sodium balance is recommended as the first step in the management process (Locatelli *et al.*, 2010). Table 2.4, as published by Prof Locatelli and co-workers (2010), summarises a comprehensive approach to the treatment of IDH.

Table 2.4: Potential strategies for the treatment of IDH

Potential strategy	Potential methods
Reduce volume overload	<ul style="list-style-type: none"> • Increase UF • Reduce cardiac output • Restrict dietary salt
Control electrolyte changes	<ul style="list-style-type: none"> • Ensure an adequate intradialytic sodium balance • Reduce dialysate calcium concentration
Reduce sympathetic over activity	<ul style="list-style-type: none"> • Administer angiotensin-converting enzyme inhibitors • Administer angiotensin II receptor blockers • Administer direct renin inhibitors • Administer adrenergic receptor blockers (α-blockers and β-blockers) • Start patient on daily dialysis • Increase duration of dialysis
Inhibit the RAAS	<ul style="list-style-type: none"> • Administer angiotensin-converting enzyme inhibitors • Administer angiotensin II receptor blockers • Administer direct renin inhibitors
Evaluate concurrent therapies	<ul style="list-style-type: none"> • Consider whether the patient's antihypertensive drugs might be removed by dialysis

(Adapted from Locatelli *et al.*, 2010)

More investigation is required to guide therapy, and to the researcher's best knowledge, no research studies on IDH have been conducted among the South African HD population. Therefore, this study was conducted to shed light on the growing problem of intradialytic hypertension.

3 | METHODOLOGY

3.1 Study location

Four HD units in the Western Cape participated in this study: Tygerberg Academic Hospital, Panorama Kidney and Dialysis Centre, Athlone Kidney and Dialysis Centre and Winelands Kidney and Dialysis Centre.

3.2 Study design

A multicentre, cross-sectional study was conducted on chronic HD patients at four adult dialysis units in the Western Cape. IDH was defined as a rise of ≥ 10 mmHg in systolic BP between pre-dialysis and post-dialysis in at least four out of six consecutive dialysis sessions. Participants deemed eligible for inclusion in the study were identified from HD charts by the primary investigator (PI). They were then approached by the PI, who obtained informed consent. Once informed consent had been obtained and no exclusion criteria had been found to be present, the patient was enrolled. A study identification number was allocated.

By using a standard operating protocol, BP and pulse rate were measured pre-dialysis, hourly on dialysis and 30 minutes after completion of dialysis. Weight and bio-impedance were determined pre-dialysis and post-dialysis using the BCM. Dialysis modality, hourly UF rates, intradialytic calcium and time-averaged sodium levels were also determined on dialysis (see Appendix A). All data extracted were captured onto a standardised data sheet (see Appendix B). This study formed part of a greater study: *A cross-sectional study on intradialytic hypertension at four haemodialysis units in the Western Cape*.

The primary objective of the greater study was to determine the prevalence of IDH in the sample group. Secondary objectives included the secondary objectives of the current study as well as evaluation of antihypertensive drugs and erythropoietin use. Dialysability of these specific drugs was also investigated.

3.3 Study layout

The layout of the current study is summarised below in Figure 3.1.

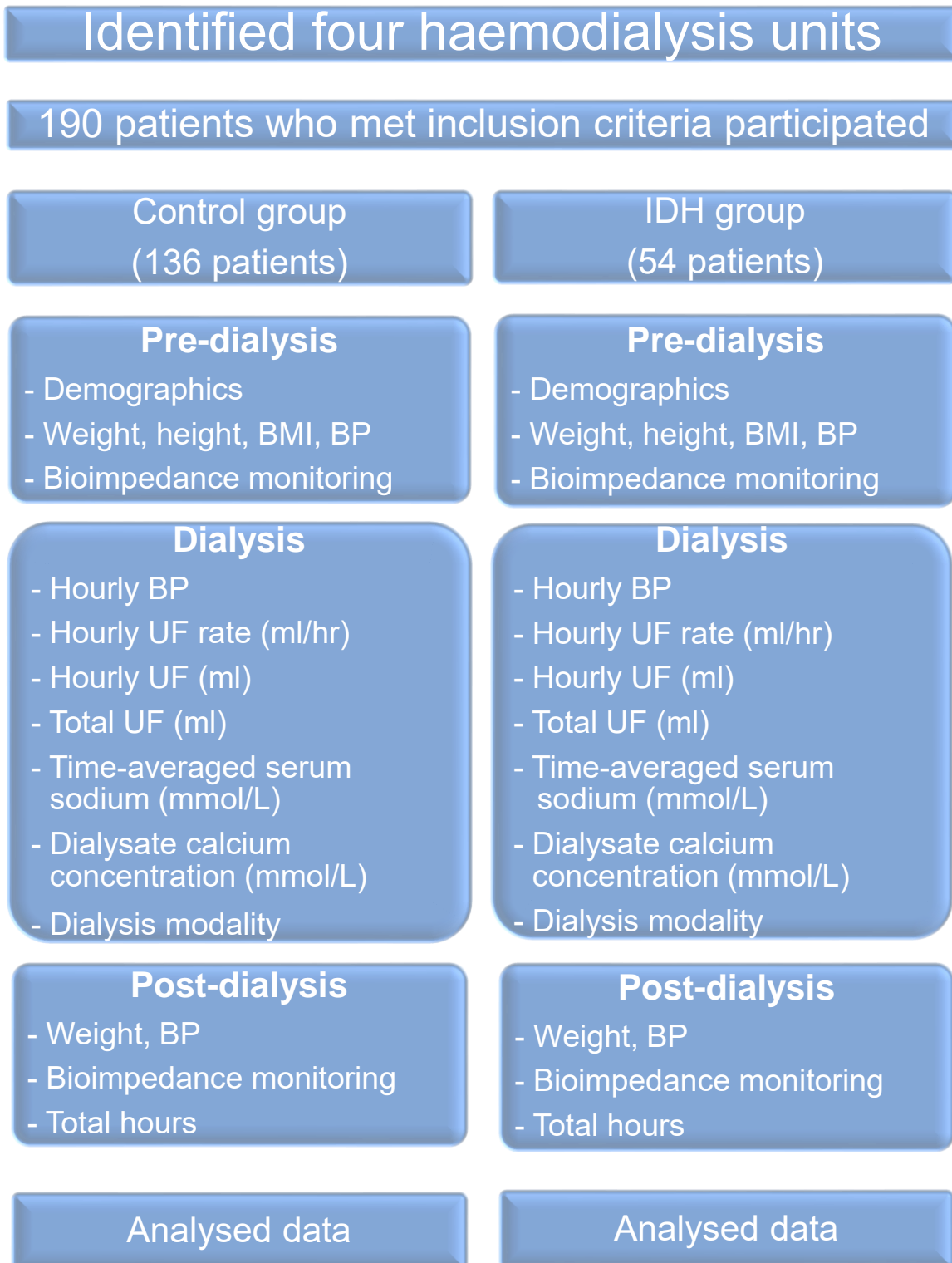

Figure 3.1: Study layout

3.4 Study population

3.4.1 Number of subjects

Two hundred and twenty-three patients were initially screened. Two hundred patients met the inclusion criteria. Three patients passed away before commencement of data collection, four received intravenous fluids of >200ml on dialysis, two patients' BCM measurements were faulty and one patient's HD circuit clotted prematurely. One hundred and ninety patients eventually participated in the study.

3.4.2 Subject identification

Patients deemed eligible for inclusion in the study were identified from the chronic dialysis programme. These patients received dialysis two to three times per week for 3–4 hours per dialysis session. They were then approached by the PI, who obtained informed consent. Once informed consent had been obtained and no exclusion criteria had been found to be present, the patient was enrolled. A study identification number was allocated, and data were captured onto a standard data collection sheet (see Appendix B).

The PI screened the dialysis charts of the enrolled patients and divided them into the two respective groups. A rise of ≥ 10 mmHg in systolic BP between pre-dialysis and post-dialysis in at least four out of six consecutive dialysis sessions defined the IDH group. The patients who did not meet these criteria were categorised in the control group.

3.4.3 Inclusion and exclusion criteria

3.4.3.1 Inclusion criteria

- Men and women aged >18 years
- On HD 2–3 times per week
- Able to give informed consent
- Able to read, write and understand English/Afrikaans/isiXhosa

3.4.3.2 Exclusion criteria

- Impossible to take BP by routine methods in the upper limbs
- Unable to give informed consent
- Patients who received intravenous fluids >200ml and/or intravenous antibiotics for intercurrent acute illness
- Contraindications pertaining to bio-impedance monitoring (pre-existing implanted cardiac devices such as pacemakers and cardioverter defibrillators; amputees)
- Pregnant patients

3.5 Measurements

The following measurements were performed on the patients:

3.5.1 Blood pressure

Systolic and diastolic BP was measured via electronic, calibrated BP modules manufactured by Fresenius Medical Care Deutschland GmbH. The BP modules are a standard fixture on the respective dialysis machines, and each is fitted with an adult-sized BP cuff with an internal bladder measuring 12cm. The systolic and diastolic BP measurements were taken by placing the cuff directly on the brachial artery on the medial side of the upper arm.

3.5.2 Bio-impedance monitoring

Four electrodes were attached to the patient: two to the anterior part of the arm, with one electrode on the wrist and one electrode on the hand (4cm apart), and two to the anterior part of the leg, with one electrode on the ankle and one electrode on the foot (4cm apart). The arm and leg used for measurements were on the same side of the body (see Figure 3.2).

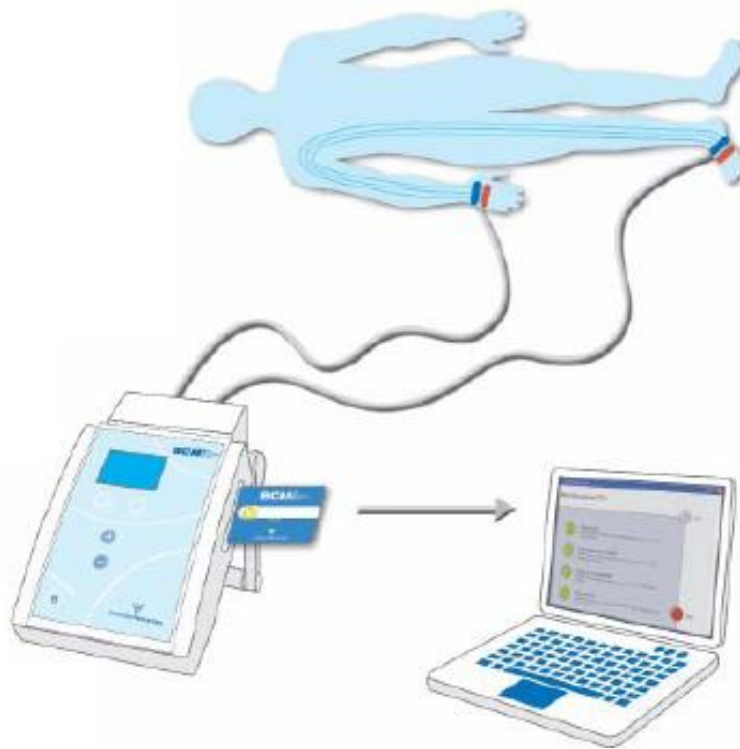

Figure 3.2: Body composition monitoring

(BCM product folder, Fresenius Medical Care Deutschland GmbH, 2007)

Bio-impedance was measured using the BCM before dialysis and 30 minutes after dialysis.

3.5.3 Interdialytic weight gain and body mass index

Patients were weighed on a designated electronic scale at the respective units. The same scale was used pre-dialysis and post-dialysis for each patient. The results were displayed in kilogram (kg), up to one decimal.

Interdialytic weight gain was calculated according to the following formula:

IDWG (kg) = pre-dialysis weight (kg) - post-dialysis weight (kg) of previous session.

IDWG was subsequently set as total UF volume (ml) goal for the dialysis session on that day.

Body mass index was calculated according to the following formula:

$$\text{BMI (kg/m}^2\text{)} = \text{weight (kg)} \div \text{height (m}^2\text{)}$$

Patients' height was measured using a fixed measuring tape calibrated in centimetres (cm), in the respective units.

3.5.4 Time-averaged serum sodium concentration on haemodialysis

Serum sodium concentrations were measured by the Online Clearance Monitor (OCM), which is a standard feature on the 4008S and 5008S HD machines from Fresenius Medical Care, used at all the dialysis units.

The OCM determines sodium concentrations at the dialysate inflow and outflow of the dialyser by monitoring conductivity through conductivity cells that are situated at the inflow and outflow points, as shown in Figure 3.3.

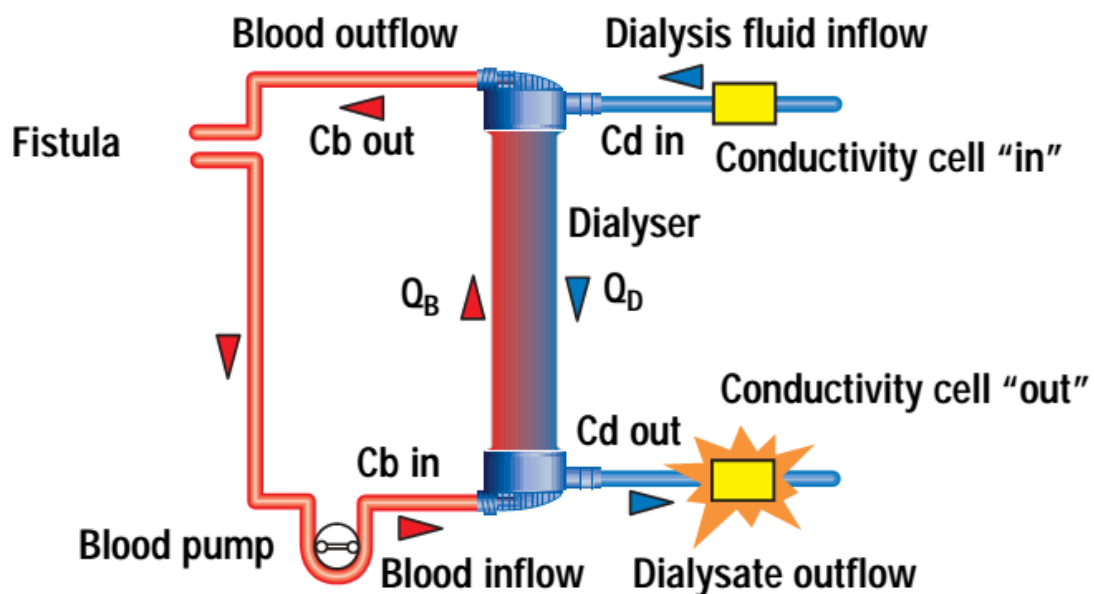

Figure 3.3: Serum sodium measurement

(OCM product folder, Fresenius Medical Care, 2003)

Q_b = blood flow (ml/min)

C_b = conductivity in the blood (mS/cm)

Q_d = dialysate flow (ml/min)

C_d = conductivity in the dialysate (mS/cm)

The difference between the values of the two conductivity cells in relation to the dialysate flow rate shows the rate of flow of sodium into or out of the patient. By using the value for clearance previously measured by the OCM, the serum concentration of sodium can be calculated. In this way, the OCM derives a value for serum sodium from each clearance measurement every 25 minutes while the patient is on dialysis. The result is adjusted by the machine's software using correction factors so that the displayed value on the dialysis machine reflects the patient's serum sodium (mmol/L). The accuracy of the result is equivalent to that obtained by means of flame photometry assay (a laboratory method for measuring sodium and potassium in biological fluids).

3.6 Data collection

Data were collected according to the standard operating protocol detailed in Appendix A.

3.7 Statistical analysis

The Centre for Statistical Consultation at Stellenbosch University was consulted. Descriptive analysis was performed looking at means \pm standard deviations, medians and interquartile ranges, histograms, box plots, frequencies, proportions, and so forth. Both unadjusted and adjusted analyses with multilinear regression (for age, gender and socioeconomic status) were used for dry weights, antihypertensive drug use, bio-impedance monitoring, erythropoietin-stimulating agent therapy and time-averaged sodium concentrations. Where data had a normal distribution, t-tests for the mean were utilised, whereas non-normally distributed data were analysed using Mann-Whitney-Hugh tests. A significant p -value was set at $p \leq 0.05$. To achieve a standard precision of 5% (95% CI), a sample size of 190 patients was needed.

3.8 Ethical aspects and good clinical practice

3.8.1 Ethical clearance

Approval from the Health Research Ethics Committee from Stellenbosch University was granted on 3 December 2012 for the greater study that the current study formed part of: *A cross-sectional study on intradialytic hypertension at four haemodialysis units in the Western Cape* with ethics reference number: S12/10/264 (see Appendix C).

This study was registered with Clinical Trials.gov in the United States of America, registration number NCT01916668 (see Appendix D).

The greater study was also presented as a poster presentation at the World Congress of Nephrology in March 2015, abstract number WCN15-0447 (see Appendix E).

3.8.2 Safety variables

3.8.2.1 Project and patient safety

The study posed no safety risks as it was an observational study and no changes were made to the patients' existing dialysis prescription. Body composition monitoring is analogous to electrocardiograph monitoring. The study did not have any impact on the routine standard of care.

3.8.2.2 Premature discontinuation of the study

The study was not discontinued by the PI or any of the study leaders due to breach of confidentiality or any unethical procedures.

3.8.2.3 Good clinical practice/quality assurance

All clinical work conducted under this protocol was subjected to the Good Clinical Practice Guidelines (The Principles of International Conference on Harmonisation: Good Clinical Practice, 1996).

The Declaration of Helsinki's (2002) Basic Principle Number 3 was adhered to in this study. It states that research should be conducted only by scientifically qualified people and under the supervision of adequately qualified people (World Medical Association, 2002).

3.8.3 Financial implications for the patient

There were no financial implications for the patients, and recruitment was voluntary.

3.8.4 Withdrawal criteria

No patient withdrew from the study during the trial period. Patients had the right to withdraw from the study at any time, irrespective of the reason(s), without detriment to their medical care at the time or in the future. Elimination of a patient from the study would not have resulted in any penalty.

3.8.5 Subject information and informed consent

Written informed consent was obtained in the home language of the patient. Consent forms were available in English, Afrikaans and isiXhosa. In the case of participants who were unable to give written consent, informed consent was witnessed.

The following were explained to the participants: the nature of the study, any procedures involved, potential risks and benefits, the right to withdraw from the study without incurring any penalty, procedures to maintain confidentiality and that participation were completely voluntary.

3.8.6 Confidentiality

In accordance with the Declaration of Helsinki of 2002, data were collected in a confidential area and a coding system (unique study identification number) was used to maintain anonymity. Permission to collect data from dialysis and prescription charts was obtained from the participants. Data were stored on the PI's computer alone, which was password protected. All documents including data collection sheets and identification coding lists were stored in a locked cupboard to which only the PI had access.

3.8.7 Conflict of interest

BCM and electrodes that were sponsored by Fresenius Medical Care were used to measure bio-impedance in this study.

4| RESULTS

Two hundred and twenty-three patients were initially screened at four dialysis units. Two hundred patients who met the inclusion criteria were selected. However, three patients passed away before data collection commenced, four received intravenous fluids of >200ml on dialysis, two patients' BCM measurements were faulty and one patient's dialysis circuit clotted prematurely. One hundred and ninety patients eventually participated in the study (see Figure 4.1).

Intradialytic hypertension was defined as a rise of ≥ 10 mmHg in systolic BP between pre-dialysis and post-dialysis in at least four out of six consecutive dialysis sessions.

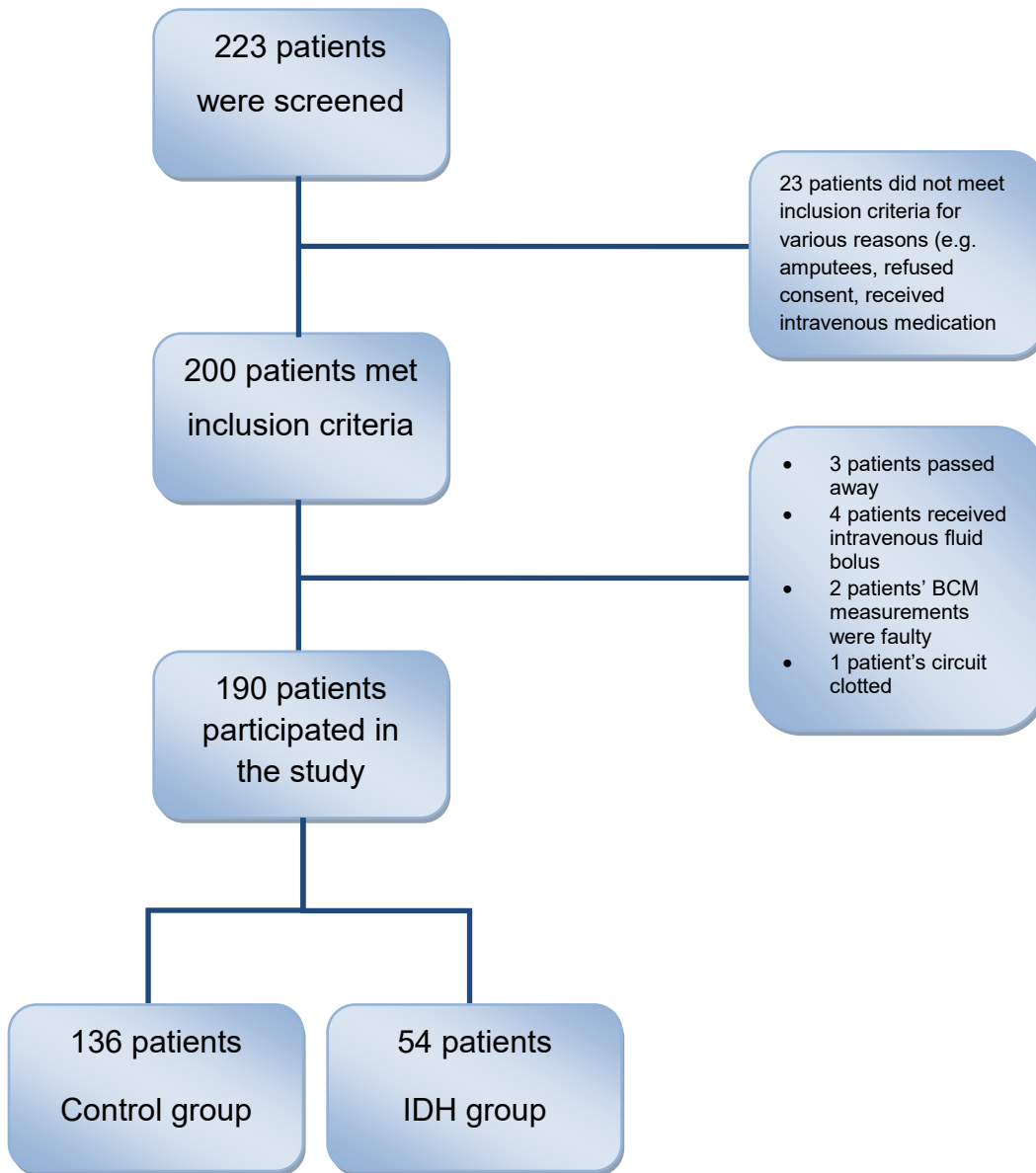

Figure 4.1: Patient participation

4.1 Primary results

The primary results showed that there was a trend toward statistical significance regarding pre-dialysis OH as measured by whole body bio-impedance (mean pre-dialysis OH was 2.6L [95% CI 1.7–3.4] vs. 1.8L [95% CI 1.4–2.10]; $p=0.06$) in IDH cases compared to controls. There was also a trend toward statistical significance in post-dialysis OH as measured by whole body bio-impedance (mean post-dialysis OH was 0.79L [95% CI -0.04–1.62] vs. -0.17L [95% CI 0.52–0.18]; $p=0.06$), as shown in Figure 4.2.

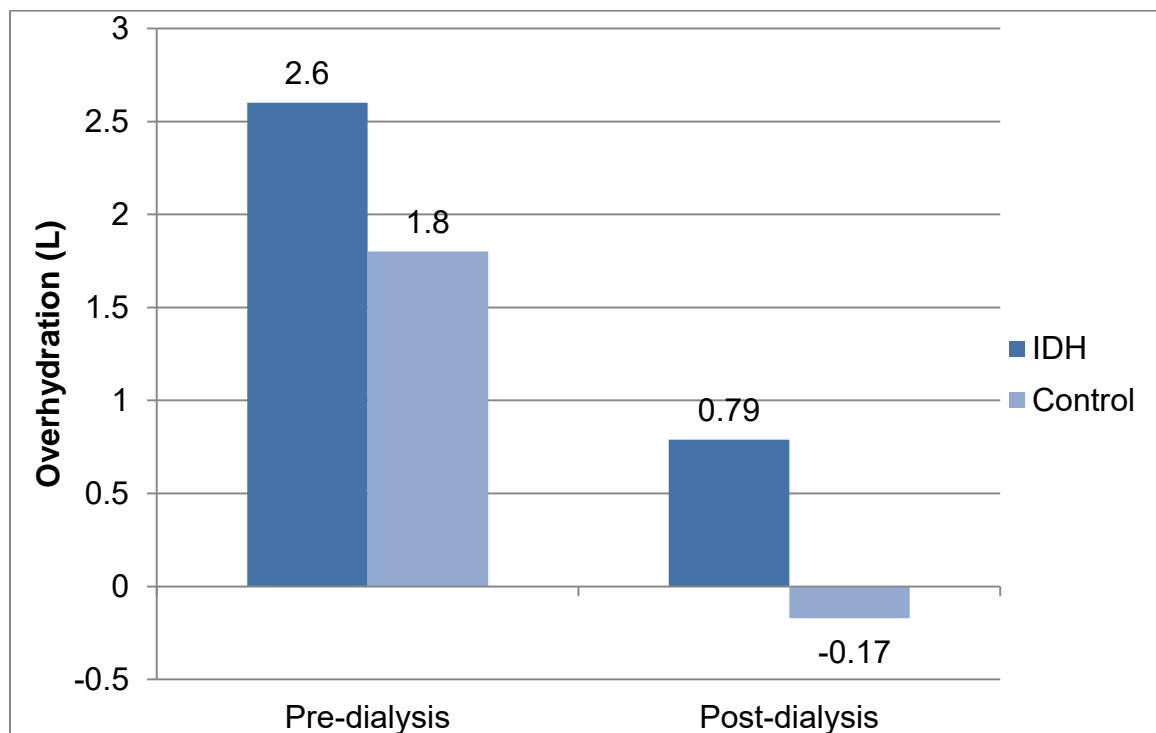

Figure 4.2: Pre-dialysis and post-dialysis OH (L) in IDH group vs. control group

The results regarding percentage ECW correlated with the OH results, as shown in Figure 4.3.

Pre-dialysis percentage ECW did not achieve a significant result as measured by whole body bio-impedance (mean pre-dialysis percentage ECW was 12.3% [95% CI 8.3–16.3] vs. 9.6% [95% CI 7.8–11.5]; $p=0.12$) in IDH cases compared to controls.

The post-dialysis results showed statistical significance with the IDH group's mean percentage ECW decreasing to 3.5% (95% CI -1.4–8.5) compared to the control group's mean percentage ECW of -1.4% post-dialysis (95% CI -3.7–0.8); $p=0.04$ (see Figure 4.3).

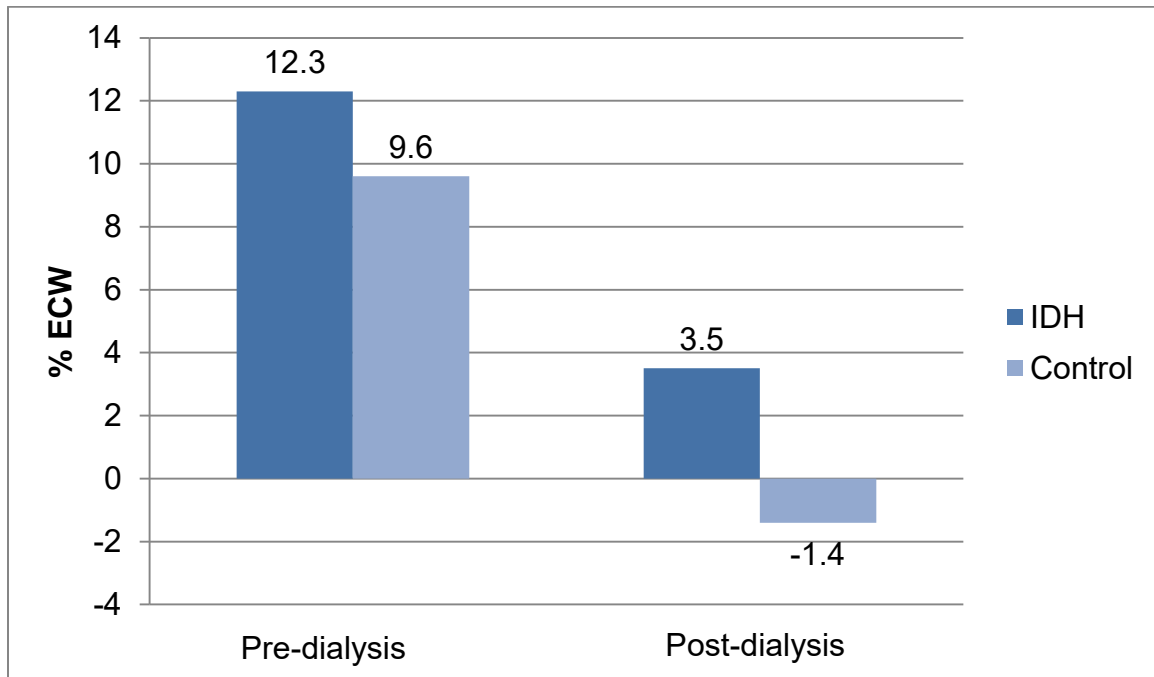

Figure 4.3: Pre-dialysis and post-dialysis percentage ECW in IDH group vs. control group

4.2 Pre-dialysis results

No differences were identified regarding mean age (57.1 years vs. 55.1 years; $p=0.42$), gender (men 53.7% vs. 59.5%; $p=0.46$) and race ($p=0.23$) in the IDH group as compared with the controls (see Table 4.1).

Table 4.1: Pre-dialysis results: Baseline demographic results

Pre-dialysis	IDH group (n=54)	Control group (n=136)	<i>p</i> -value
Demographics			
Mean age (years)	57	55	0.42
Male (%)	53	59	0.46
White (%)	46	33	0.23
Black (%)	11	14	0.23
Coloured (%)	42	52	0.23

$p < 0.05$ indicates a statistically significant difference

There were no differences in mean weight (74kg vs. 77kg; $p=0.26$) or BMI (26kg/m² vs. 27kg/m²; $p=0.55$). There was a statistically significant difference in mean systolic BP pre-dialysis (159mmHg vs. 150mmHg; $p=0.04$) in the IDH group as compared with the control group (see Table 4.2).

Table 4.2: Pre-dialysis results: Clinical data

Pre-dialysis	IDH group (n=54)	Control group (n=136)	p-value
Clinical data			
Mean weight (kg)	74	77	0.26
Mean BMI (kg/m ²)	26	27	0.55
Mean systolic BP (mmHg)	159	150	0.04
Mean diastolic BP (mmHg)	76	73	0.41
MAP (mmHg)	103	99	0.11

$p < 0.05$ indicates a statistically significant difference

BMI = body mass index

BP = blood pressure

MAP = mean arterial pressure

Pre-dialysis OH and percentage ECW results are discussed in the Primary results (4.1) section and depicted in Figures 4.2 and 4.3.

4.3 Dialysis results

Mean systolic BP showed a significant difference between the two groups (158mmHg vs. 136mmHg; $p < 0.001$) on dialysis (see Figure 4.4).

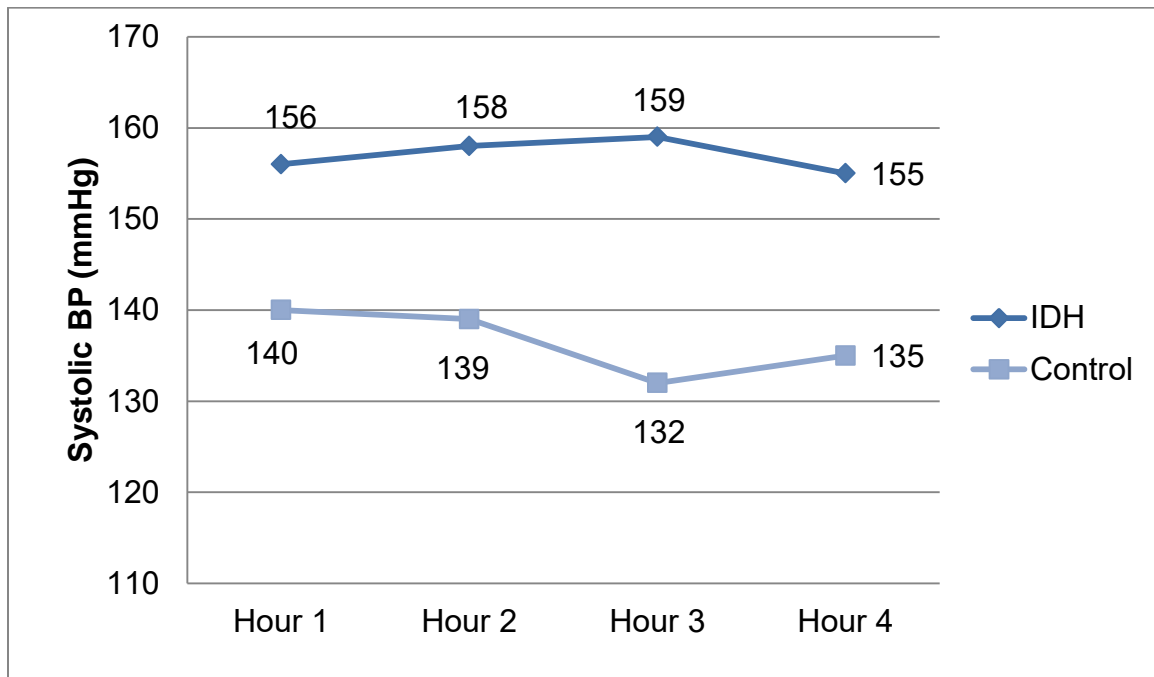

Figure 4.4: Mean hourly systolic BP during dialysis in IDH group vs. control group

The hourly UF rate was lower throughout the four-hour dialysis procedure in the IDH group compared to the control group. The difference in mean UF rate (609ml/hr vs. 641ml/hr) was not statistically significant ($p=0.52$).

There was no statistically significant difference in mean total UF volume in the IDH group versus the control group (2 273ml vs. 2 461ml; $p=0.32$), as depicted in Figure 4.5.

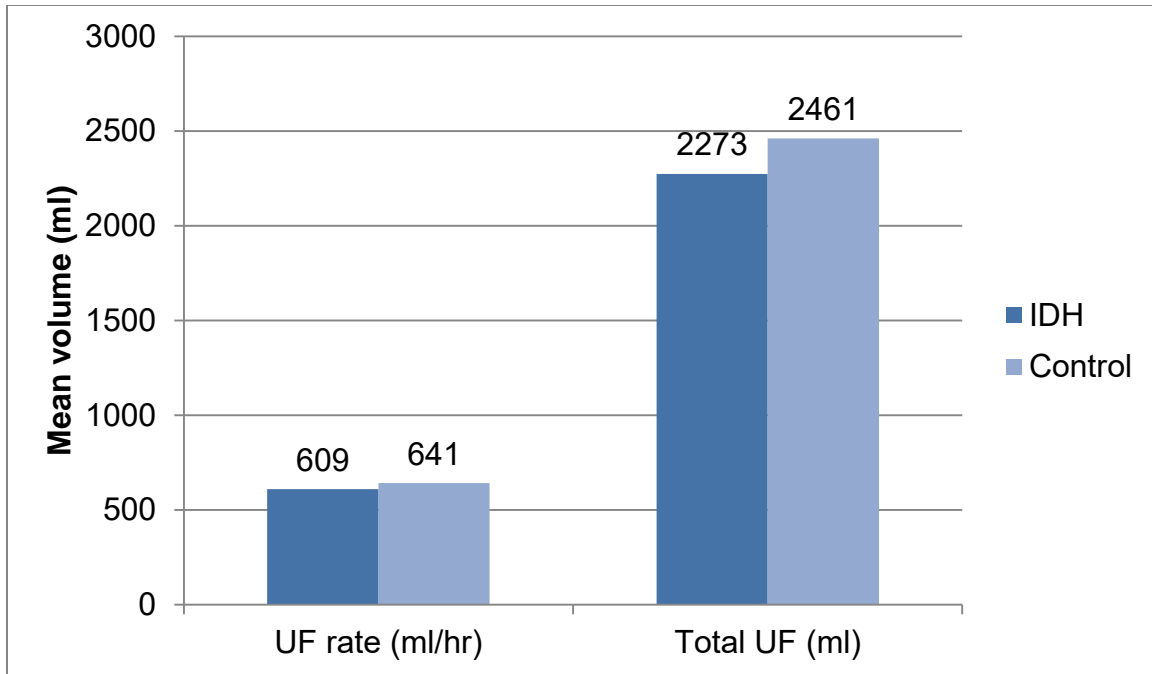

Figure 4.5: Fluid removal on dialysis: Mean UF rate per hour over four hours (to the left) and total UF over four hours (to the right) for IDH group vs. control group

There were no differences in mean time-averaged sodium concentrations (138.3mmol/L vs. 138.4mmol/L; $p=0.72$) or mean dialysate calcium concentrations (1.34mmol/L vs. 1.36mmol/L; $p=0.45$). There was no statistically significant difference in the proportion of patients on the two dialysis modalities (HD:HDF): IDH group (19%:81%) versus control group (21%:79%) ($p=0.66$), as shown in Table 4.3.

Table 4.3: Dialysis results: Clinical data

Dialysis	IDH group (n=54)	Control group (n=136)	p-value
Clinical data			
Mean time-averaged sodium (mmol/L)	138.3	138.4	0.72
Dialysate related			
Mean dialysate calcium (mmol/L)	1.34	1.36	0.45
Dialysis modality			
HD (%)	19	21	0.66
HDF (%)	81	79	0.66

$p < 0.05$ indicates a statistically significant difference

HD = haemodialysis

HDF = haemodiafiltration

4.4 Post-dialysis results

Mean systolic BP was significantly different at the end of dialysis between the two groups (155mmHg vs. 135mmHg; $p<0.001$) (see Figure 4.4); however, there was no significant difference in mean weight post-dialysis (72kg vs. 76kg; $p=0.31$) in the IDH group as compared with the control group, as shown in Table 4.4.

Table 4.4: Post-dialysis results: Clinical data

Post-dialysis	IDH group (n=54)	Control group (n=136)	p-value
Clinical data			
Mean systolic BP (mmHg)	155	135	<0.001
Mean diastolic BP (mmHg)	79	70	0.004
MAP (mmHg)	104	92	<0.001
Mean weight (kg)	72	76	0.31

$p<0.05$ indicates a statistically significant difference

BP = blood pressure

MAP = mean arterial pressure

The total number of hours on dialysis per week was less in the IDH group as compared to the control group (10.85 hours vs. 11.11 hours; $p=0.29$); however, this did not reach statistical significance, as shown in Figure 4.6.

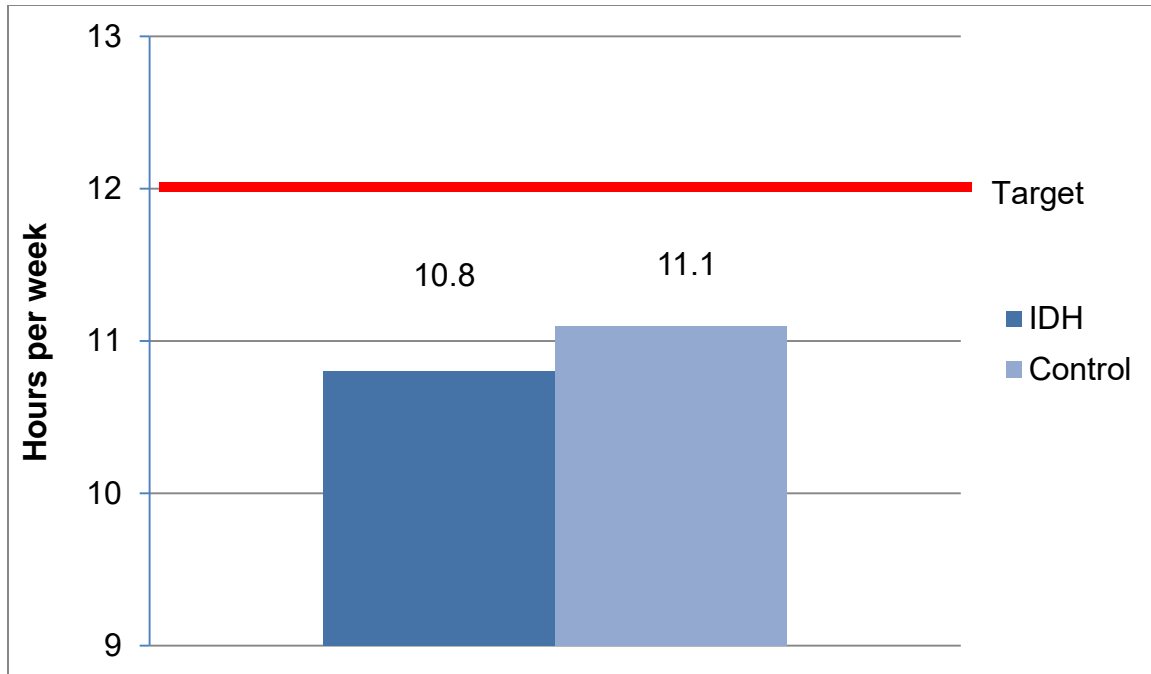

Figure 4.6: Mean total hours per week on dialysis for IDH group vs. control group

5 | DISCUSSION AND CONCLUSION

5.1 Primary results

The primary results showed that there was a trend toward statistical significance with regard to pre-dialysis OH status ($p=0.06$) as well as post-dialysis OH status ($p=0.06$). The IDH patients, however, showed no clinical features of fluid overload. Several other studies have also found that subclinical volume overload is associated with IDH (Cirit *et al.*, 1995; Gunal *et al.*, 2002). Agarwal *et al.* (2010) reported a post-dialysis weight reduction of 0.9kg over four weeks that resulted in a drop of 6.9mmHg ($p=0.016$) in systolic intradialytic BP.

Chronic fluid overload results from escalating fluid accumulation when interdialytic fluid gain is not removed on individual dialysis sessions due to possible hemodynamic instability or other complications such as cramping.

When combined with non-adherence to interdialytic salt and fluid intake, this may result in small gains of excess fluid over a long period of time (Levy *et al.*, 2010). When dry weight is not assessed regularly and managed effectively, subclinical fluid overload can accumulate in such a way that it may present serious clinical consequences later such as IDH (see Figure 4.5), ambulatory hypertension and left ventricular hypertrophy as reported by London (2003). Subclinical fluid overload produces no symptoms or signs such as pedal oedema, hypertension, cardiac dysfunction or shortness of breath and is often overlooked in dialysis patients.

Onofriescu *et al.* (2014) reported a similar concern when dry weight in dialysis patients was assessed according to clinical methods rather than bio-impedance measurements. In this study 131 patients were followed up over a period of 3.5 years.

Relative fluid overload decreased from 9.52% to 7.46% ($p=0.03$) in the bio-impedance group while the control group actually gained fluid from 10.30% to 11.24% in the same period. This supports the evidence that clinical assessment of fluid overload is not always reliable.

Furthermore, the extreme fluid and consequent volume shifts that dialysis patients are exposed to during UF, cause significant cardiovascular strain (London, 2003). When this is combined with co-morbidities such as diabetes mellitus, progression of cardiovascular disease is the unfortunate outcome. Antlanger *et al.* (2013) reported a similar conclusion that chronic fluid overload was associated with higher mortality rates in dialysis patients and could be used as a biomarker for cardiovascular risk in the HD population. Similar results for subclinical fluid overload were also obtained by numerous previous studies, as reported by Cirit *et al.* (1995), Agarwal *et al.* (2010) and Nongnuch *et al.* (2014).

Cirit *et al.* (1995) reported on patients who presented with marked cardiac dilatation and high blood pressure, but most did not have signs of oedema associated with hypervolaemia. They were treated with repeated intense UF. After a variable time period, all the patients became normotensive without additional medication.

A recent publication by Nongnuch *et al.* (2014) compared the ratio of ECW to TBW. The authors performed a prospective audit involving 531 HD patients who also underwent bio-impedance monitoring. Their findings were that patients who had a rise in BP post-dialysis had an elevated ECW: TBW ratio before and after dialysis. Their suggestion was that patients who had increased BP post-dialysis were most likely to be volume overloaded. In this study, the IDH group's average IDWG was 187.96ml less compared to that of the control group ($p=0.32$), as shown in Figure 4.5.

The results of the bio-impedance monitoring however showed that the IDH group had higher OH (L) pre-dialysis (see Figure 4.2) and subsequent elevated percentage ECW (see Figure 4.3) compared to the control group ($p=0.12$). This OH was subclinical and the patients presented with no signs of fluid overload. The IDH group's mean pre-dialysis percentage ECW was 12.3% compared to the control group which was slightly less at 9.6% ECW (see Figure 4.3). Our post-dialysis percentage ECW result showed statistical significance with the IDH group's mean decreasing to 3.5% compared to the control group's mean percentage ECW of -1.4% ($p=0.04$), as depicted in Figure 4.3. This signifies that patients with IDH did not reach dry weight post-dialysis which may be related to shorter total dialysis duration.

The percentage ECW as measured by the BCM may not necessarily reflect OH, as the distribution of the fluid in this compartment may vary according to nutritional status, specifically due to variability of serum albumin levels, which was not included in this study.

5.2 Pre-dialysis results

There was no significant difference between the two groups in terms of patients' age, gender or race distribution (see Table 4.1). The mean age of the study population was 56 years which was similar to the mean age of 54 years as reported by Agarwal *et al.* (2010) and Van Buren *et al.* (2011). However, in one of the dialysis units who contributed to patient recruitment, the prevalence of IDH was 70%. The mean age of patients in this unit was 65 years. It may be that older age contributes to IDH due to greater vascular stiffness.

Our study population was overweight as measured by BMI. The BMI results for both groups were both above 25kg/m², with the IDH group at 26kg/m² versus 27kg/m² for the control group. Antlanger *et al.* (2013) reported a negative association regarding BMI and fluid overload, particularly with a BMI >30kg/m².

Although the difference in BMI results for this study was not statistically significant, it contradicts Antlanger's findings as the IDH group showed a trend towards fluid overload despite a lower BMI compared to the control group (see Table 4.2).

There was a statistically significant difference in mean systolic BP in the IDH group versus the control group. The IDH group had a 9mmHg higher systolic BP pre-dialysis (see Table 4.2). This phenomenon may be explained by the position patients find themselves on the Frank Starling curve. In the case of the IDH group, their position may be to the right of the Starling curve as opposed to the control group which may be to the left, similar to the findings reported by Gunal *et al.* (2002). However, Van Buren *et al.* (2011) and Nongnuch *et al.* (2014) reported lower pre-dialysis systolic BP in the IDH group compared to the control group.

5.3 Dialysis results

There was a statistical significant difference between the two groups with regards to hourly systolic BP changes during dialysis. Figure 4.4 reveals the increase in systolic BP in the IDH group while the control group's systolic BP decreased during the dialysis procedure.

However, the decrease in systolic BP was greater in the control group as compared with the rise in systolic BP in the IDH group. This is indicative of resistance of the IDH group to UF. It may be that the control group is closer to their dry weights at the start of dialysis as compared to the IDH group.

As the mean UF rate per hour (see Figure 4.5) and subsequent total mean UF (see Figure 4.5) for the IDH group during the dialysis session were lower compared to the control group, an increased sympathetic response to ultrafiltration is unlikely to be a major contributing factor. Chou *et al.* (2006) reported that patients with IDH had an increase in peripheral vascular resistance (PVR) but this could not be explained by an increase in sympathetic output. However, the increase in PVR may be explained by an imbalance of nitric oxide and endothelin-1 levels.

According to the National Kidney Foundation - Kidney Disease Outcomes Quality Initiative guidelines published in 2005 (NKF KDOQI, 2005), a positive sodium balance is the main mechanism of extracellular fluid overload and hypertension in dialysis patients.

There was no difference between the two groups with regard to time-averaged sodium concentration in this study: in the IDH group, serum sodium of 138.3mmol/L compared to the control group with serum sodium at 138.4mmol/L ($p=0.72$), as shown in Table 4.3.

However, a more reliable marker of sodium gain would have been to assess the patients' serum sodium concentration pre-dialysis to determine if a concentration gradient was present for the absorption of sodium into the plasma during dialysis (Locatelli *et al.*, 2010). Nongnuch *et al.* (2014) reported no difference in the dialysate to serum sodium gradient as well as pre-serum and post-serum sodium.

No statistical significance was achieved between the two groups with the mean dialysate calcium concentrations ($p=0.45$). The dialysate calcium level tends to equilibrate with the ionized fraction of the serum calcium (1.1mmol/L to 1.5mmol/L). Serum calcium can be classified in 3 categories: protein bound (40%), complexes (14%) and ionized (46%). The ionized and calcium complexes are dialyzable (Sam *et al.*, 2006). Sam *et al.* (2006) further reported that dialysate with a calcium concentration of 1.63mmol/L or higher could lead to transient hypercalcaemia with symptoms of nausea and vomiting.

It has been shown that the use of a low calcium dialysate (1.25mmol/L) is associated with a mild but significant decline in the mean BP during dialysis (Sam *et al.*, 2006). The decline in BP is mediated by a decrease in cardiac contractility due to lower serum calcium levels.

Chou *et al.* (2006) and Nongnuch *et al.* (2014) reported similar results to this study, whereby there were no calcium variations between the IDH and control groups.

A similar distribution of the groups between the two dialysis modalities, HD and HDF ($p=0.66$), was observed, as shown in Table 4.3.

Canaud *et al.* (2000) and Maduell *et al.* (2013) both reported that HDF was a more effective form of dialysis, with a 33% lower risk of cardiovascular mortality as well as more haemodynamic stability intradiallytically compared to conventional HD in terms of intradiallytic hypotension. However, nothing has been reported in favour of HDF compared to HD where intradiallytic hypertension is concerned.

5.4 Post-dialysis results

A concerning factor is that the IDH group's mean effective time on dialysis per week was less than the control group's (see Figure 4.7). The IDH group's dialysis time per week was 10 hours 51 minutes versus the control group at 11 hours 6 minutes ($p=0.29$). This did not reach statistical significance; however, it was suggested that this may be clinically significant as this can result in less UF in the long term. Nongnuch *et al.* (2014) also found no major differences in dialysis prescription (including time on dialysis) when comparing the IDH to the control or hypotensive groups in their study.

The European Best Practice Guidelines (2007) clearly state in Guideline 1.1 "Dialysis should be delivered at least 3 times per week and the total duration should be at least 12 hours per week, unless supported by significant renal function." (EBPG, 2007).

Both the control group and the IDH group in this study received mean weekly hours of less than 12 hours on dialysis, however when the hours are calculated on a monthly basis, the IDH group received 60 minutes less dialysis compared to the control group. Less dialysis equals less UF and thus excess fluid will accumulate over time as discussed previously.

5.5 Limitations of the study

This study had numerous limitations:

- The study was not powered to find a difference in fluid status, as this was a secondary outcome of a greater study that was powered to find a prevalence of IDH of 15%.
- Sodium and calcium gradients were not determined.
- Only a single dialysis session for each patient was investigated.
- The midweek dialysis session was investigated in the majority of the patients. However, a small number of patients received dialysis twice a week and did not attend midweek sessions. This resulted in a longer interdialytic period, which would have affected the IDWG.
- Other causes of fluid overload (for example cardiac disease or ongoing nephritic syndrome) were not excluded.
- Dietary indiscretions by the patients were not excluded at the time. Nutritional status, especially serum albumin levels, may influence movement of fluid between the fluid compartments.
- The BCM's contraindications limited the number of patients who met the inclusion criteria; for example, patients with amputations and pacemakers needed to be excluded as they are contraindicated in whole body bio-impedance monitoring.

5.6 Recommendations

A cross sectional IDH study, involving a larger sample group to determine the difference in hydration status would be a far more reliable approach to confirm the causes of IDH as reported by this study and several others to date (Cirit *et al.*, 1995; Gunal *et al.*, 2002; Chou *et al.*, 2006; Agarwal *et al.*, 2010; Nongnuch *et al.*, 2014).

Investigative parameters should include data as captured by this study as well as the following:

- Cardiac history
- Nutritional status
- Segmental bio-impedance measurement
- Serum and dialysate sodium gradient
- Serum and dialysate calcium gradient

5.7 Conclusion

There is a statistically significant trend towards a difference in hydration status between patients who develop IDH compared to patients with stable BP on dialysis. Similar results were obtained by Cirit *et al.* (1995), Gunal *et al.* (2002), Agarwal *et al.* (2010) and Nongnuch *et al.* (2014).

In conclusion, IDH may be due to subclinical fluid overload as measured by bio-impedance spectroscopy.

In practice, accurate fluid assessment via bio-impedance spectroscopy is paramount to effectively assess HD patients' overhydration status. Subsequently patients can be maintained in an euvolaemic state via adequate UF and ultimately hypertension can be managed more effectively. This could contribute significantly to minimise hypertension as a cardiovascular risk factor in HD patients.

| BIBLIOGRAPHY

Agarwal, R. & Light, R.P. 2010. Intradialytic hypertension is a marker of volume excess. *Nephrology Dialysis Transplantation*, October 25 (10):3355–3361.

Antlanger, M., Hecking, M., Haidinger, M., Werzowa, J., Kovarik, J., Paul, G., Eigner, M., Bonderman, D., Hörl, W.H. & Säemann, M.D. 2013. Fluid overload in hemodialysis patients: A cross-sectional study to determine its association with biomarkers and nutritional status. *BMC Nephrology*, (14):266.

Buckner, F.S., Eschbach, J.W., Haley, N.R., Davidson, R.C. & Adamson, J.W. 1990. Hypertension following erythropoietin therapy in anemic hemodialysis patients. *American Journal of Hypertension*, December 3 (12 Pt 1):947–955.

Canaud, B., Bosc, J.Y., Leray-Moragues, H., Stec, F., Argiles, A., Leblanc, M. & Mion, C. 2000. Online haemodiafiltration: Safety and efficacy in a long-term clinical practice. *Nephrology Dialysis Transplantation*, 15 (1):60–67.

Chazot, C. & Jean, G. 2010. Intradialytic hypertension: It is time to act. *Nephron Clinical Practice*, 115 (3):182–188.

Chou, K.J., Lee, P.T., Chen, C.L., Chiou, C.W., Hsu, C.Y., Chung, H.M., Liu, C.P. & Fang, H.C. 2006. Physiological changes during hemodialysis in patients with intradialysis hypertension. *Kidney International*, May 69 (10):1833–1838.

Cirit, M., Akcicek, F., Terzioglu, E., Soydas, C., Ok, E., Ozbasli, C.F., Basci, A. & Mees, E.J. 1995. 'Paradoxical' rise in blood pressure during ultrafiltration in dialysis patients. *Nephrology Dialysis Transplantation*, 10 (8):1417–1420.

Covic, A., Bejan, C., Klein, C., Cretu, O., Ionescu, D. & Himmele, R. 2009. Body composition monitoring (BCM) in peritoneal dialysis patients: Objective assessment of overhydration, blood pressure and nutritional status. *Peritoneal Dialysis International*, 29 (10):S21–S22.

Davids, M., Marais, N. & Jacobs, J. 2014. *South African Renal Registry Annual Report 2012*. South African Renal Society: 1–18 [Online]. Available: <http://www.kidney-international.org> [2014, April 23].

Denhaerynck, K., Manhaeve, D., Dobbels, F., Garzoni, D., Nolte, C. & De Geest, S. 2007. Prevalence and consequences of nonadherence to haemodialysis regimens. *American Journal of Critical Care*, 16 (3):222–235.

European Best Practice Guidelines (EBPG). 2007. EBPG guideline on dialysis strategies. *Nephrology Dialysis Transplantation*, May 22 (Supplement 2):ii5–ii21.

Fourtounas, C. 2010. "Malignant" intradialytic hypertension: A severe form of intradialytic hypertension. *American Journal of Kidney Diseases*, August 56 (2):418–419.

Fresenius Medical Care Deutschland GmbH. 2003. *Online clearance monitoring: Dialysis efficiency becomes measurable*. Bad Homburg: 1–28.

Fresenius Medical Care Deutschland GmbH. 2004. *Sodium and UF profiles in dialysis: Structure, application and effect*. Bad Homburg: 1–68.

Fresenius Medical Care Deutschland GmbH. 2007. *Online haemodiafiltration – the therapy guide*. Bad Homburg: 1–64.

Fresenius Medical Care Deutschland GmbH. 2012. *Living with dialysis: Nephrocare, helping you to live life to the full*. Bad Homburg: 1–72.

Gunal, A.I., Karaca, I., Celiker, H., Ilkay, E. & Duman, S. 2002. Paradoxical rise in blood pressure during ultrafiltration is caused by increased cardiac output. *Journal of Nephrology*, January–February 15 (1):42–47.

Inrig, J.K., Oddone, E.Z., Hasselblad, V., Gillespie, B., Patel, U.D., Reddan, D., Toto, R., Himmelfarb, J., Winchester, J.F., Stivelman, J., Lindsay, R.M. & Szczech, L.A. 2007. Association of intradialytic blood pressure changes with hospitalization and mortality rates in prevalent ESRD patients. *Kidney International*, March 71 (5):454–461.

Inrig, J.K., Patel, U.D., Toto, R.D. & Szczech, L.A. 2009. Association of blood pressure increases during hemodialysis with 2-year mortality in incident hemodialysis patients: A secondary analysis of the Dialysis Morbidity and Mortality Wave 2 Study. *American Journal of Kidney Diseases*, November 54 (5):881–890.

Inrig, J.K., Van Buren, P., Kim, C., Vongpatanasin, W., Povsic, T.J. & Toto, R.D. 2011. Intradialytic hypertension and its association with endothelial cell dysfunction. *Clinical Journal of the American Society of Nephrology*, August 6 (8):2016–2024.

Kidney Disease: Improving Global Outcomes (KDIGO). 2009. Clinical practice guideline for the diagnosis, evaluation, prevention, and treatment of chronic kidney disease - mineral and bone disorder. *Kidney International Supplements*, (113):s1–132 [Online]. Available: <http://www.kidney-international.org> [2014, June 7].

Kidney Disease: Improving Global Outcomes (KDIGO). 2012a. Clinical practice guideline for the diagnosis, evaluation, prevention, and treatment of chronic kidney disease. *Kidney International Supplements*, (3:1):s1–150 [Online]. Available: <http://www.kidney-international.org> [2014, June 3].

Kidney Disease: Improving Global Outcomes (KDIGO). 2012b. Clinical practice guideline for the management of blood pressure in CKD. *Kidney International Supplements*, (2):337–414 [Online]. Available: <http://www.kidney-international.org> [2014, June 3].

Leggat, J.E., Orzol, S., Hulbert-Shearon, T.E., Golper, T.A., Jones, C.A., Held, C.J. & Port, F.K. 1998. Noncompliance in hemodialysis: Predictors and survival analysis. *American Journal of Kidney Disease*, July 32 (1):139–145.

Levin, A., Singer, J., Thompson, C.R., Ross, H. & Lewis, M. 1996. Prevalent left ventricular hypertrophy in the pre-dialysis population: Identifying opportunities for intervention. *American Journal of Kidney Disease*, 27 (3):347–354.

Levy, J., Brown, E., Daley, C. & Lawrence, A. 2010. *Oxford handbook of dialysis*. 3rd edition. New York: Oxford University Press. p. 6, 26, 77.

Locatelli, F., Cavalli, A. & Tucci, B. 2010. The growing problem of intradialytic hypertension. *Nature Reviews Nephrology*, January 6 (1):41–48.

Locatelli, F., Covic, A., Chazot, C., Leunissen, K., Luño, J. & Yaqoob, M. 2004. Optimal composition of the dialysate, with emphasis on its influence on blood pressure. *Nephrology Dialysis Transplantation*, April 19 (4):785–796.

London, G.M. 2003. Cardiovascular disease in chronic renal failure: Pathophysiologic aspects. *Seminars in Dialysis*, 16 (2):85–94.

Maduell, F., Moreso, F., Pons, M., Ramos, R., Mora-Macia, J., Carreras, J., Soler, J., Torres, F., Campistol, J.M. & Martinez-Castelao, A. 2013. High-efficiency post dilution online haemodiafiltration reduces all-cause mortality in haemodialysis patients. *Clinical Journal of the American Society of Nephrology* [Online] (24):1–11. Available: <http://www.jasn.org> [2013, February 19].

Moissl, U., Wabel, P., Chamney, P.W., Levin, N., Boser-Westphal, A., Korth, O., Miller, M.J., Ellegird, L., Malmros, V., Kaitwatcharachai, C., Kuhlmann, M.K., Zhu, F. & Fuller, N.J. 2006. Body fluid volume determination via body composition spectroscopy in health and disease. *Physiological Measurement*, September 27 (9):921–933.

National Kidney Foundation: *Kidney Disease Outcomes Quality Initiative (NKF KDOQI) guidelines*. 2005. KDOQI Clinical practice guidelines for cardiovascular disease in dialysis patients. Section II: Guidelines on management of cardiovascular risk factors, guideline 12: Blood pressure. [Online] Available: http://www2.kidney.org/professionals/KDOQI/guidelines_cvd/guide12.htm [2013, October 2]

Nongnuch, A., Campbell, N., Stern, E., El-Kateb, S., Fuentes, L. & Davenport, A. 2014. Increased post-dialysis systolic blood pressure is associated with extracellular overhydration in hemodialysis patients. *Kidney International* [Online] (7):276–282. Available: <http://www.nature.com> [2014, August 2].

Onofriescu, M., Hogas, S., Voroneanu, L., Apetrii, M., Nistor, I., Kanbay, M. & Covic, A.C. 2014. Bio-impedance guided fluid management in maintenance haemodialysis: A pilot randomized controlled trial. *American Journal of Kidney Diseases*, July 64 (1):111–118.

Sam, R., Vasseemudin, M., Leong, W.H., Rogers, B.F., Kjellstrand, C.M. & Ing, T.S. 2006. Composition and clinical use of hemodialysates. *Hemodialysis International*, January 10 (1):15–28.

Teng, J., Tian, J., LV W, Zhang, X.Y., Zou, J.Z., Fang, Y., Yu, J., Shen, B., Liu, Z.H. & Ding, X.Q. 2014. Inappropriately elevated endothelin1 plays a role in the pathogenesis of intradialytic hypertension. *Hemodialysis International* [Online] (12238):1–8. Available: <http://www.http://onlinelibrary.wiley.com/doi/10.1111/hdi.12238/pdf> [2014, October 30].

The Principles of International Conference on Harmonisation: *Guideline for Good Clinical Practice*. 1996. [Online] E6 (R1):1–59. Available: http://www.ich.org/fileadmin/Public_Web_Site/ICH_Products/Guidelines/Efficacy/E6/E6_R1_Guideline.pdf [2013, October 2].

Van Buren, P.N., Kim, C., Toto, R. & Inrig, J.K. 2011. Intradialytic hypertension and the association with interdialytic ambulatory blood pressure. *Clinical Journal of the American Society of Nephrology*, July (6):1684–1691.

Wabel, P., Chamney, P., Moissl, U. & Jirka, T. 2009. Importance of whole body bio-impedance spectroscopy for the management of fluid balance. *Blood Purification*, 27:75–80.

World Medical Association Declaration of Helsinki: Ethical principles for medical research involving human subjects. 2002. *Journal of postgraduate medicine*. [Online] July-September, 48 (3): 206–208. Available: <http://www.wma.net/en/30publications/10policies/b3/17c.pdf> [2013, October 2].

| APPENDICES

Appendix A: Standard operating protocol

Dialysis unit nursing staff, technologists and application specialists were briefed about the study in advance by the primary investigator (PI).

Patients' blood pressure (BP) was recorded using standardised electronic online BP monitors as fitted onto haemodialysis machines in accordance to the guidelines set by the South African Hypertension Society.

On the study day, the nursing staff, the application specialists and the PI sequentially visited the patients and performed the tasks set out below:

Pre-dialysis

Nursing staff

- Take the patient's weight and height.
- Record BP and pulse rate.

PI

- Reviews the patient's prescription and performs whole body bio-impedance measurement.
- Records dialysis modality, dialysate calcium concentration, intradialytic weight gain, body mass index, erythropoietin-stimulating agent dose and route of administration, antihypertensives (type and dosage) and haemodialysis modality.

Dialysis

Nursing staff

- Record the patient's BP and pulse rate using electronic online BP monitor hourly for four hours.
- Document standard dialysis hourly observations for duration of dialysis.
- Record time-averaged sodium towards the end of the dialysis session.

Post-dialysis

Nursing staff

- Record the patient's weight, BP and pulse rate 30 minutes after end of dialysis.

PI

- Performs whole body bio-impedance measurement.

Appendix B: Example of data collection sheet

Date	Patient ID nr	Unit	Age	Sex	Race	Group

Nr of AHPT	Timing of AHPT	ESA dosage	Route of ESA admin

Weight (kg)			Height (m)	BMI (kg/m ²)	BCM (OH in L)	
Dry	Pre-HD	Post-HD			Pre-HD	Post-HD

BCM (% ECW)		Time avg Na (mmol/L)	Dialysate Ca (mmol/L)	HD/HDF
Pre-HD	Post-HD			

BP pre-HD (mmHg)		Hourly HD observations			
Sys	Dia	Sys	Dia	UF rate (ml/hr)	Total UF (ml)

Session length (hrs)	Sessions per week
Investigator's name	
Signature	

Appendix C: Ethics approval



UNIVERSITEIT • STELLENBOSCH • UNIVERSITY
jou kennisvennoot • your knowledge partner

Approval Notice New Application

03- Dec- 2012

SEBASTIAN, Sajith

Dear Dr Sajith SEBASTIAN,

The New Application received on 18-Oct-2012, was reviewed by Health Research Ethics Committee 1 via Committee Review procedures on 28-Nov-2012 and has been approved.

Please note the following information about your approved research protocol:

Protocol Approval Period: 28-Nov-2012 - 28-Nov-2013

Present Committee Members:

Kinnear, Craig CJ

Seedat, Soraya S

Mukosi, M

Theunissen, Marie ME

Kearns, E

Meintjes, WAJ Jack

Mohammed, Nazli

Weber, Franklin CFS

Nel, Etienne EDLR

Sprenkels, Marie- Louise MHE

Rohland, Elvira EL

Theron, Gerhardus GB

Els, Petrus PJJS

De Roubaix, Malcolm JAM

Hendricks, Melany ML

Welzel, Tyson B

Barsdorf, Nicola

Please remember to use your protocol number (S12/10/264) on any documents or correspondence with the HREC concerning your research protocol.

Please note that the HREC has the prerogative and authority to ask further questions, seek additional information, require further modifications, or monitor the conduct of your research and the consent process.

After Ethical Review:

Please note a template of the progress report is obtainable on www.sun.ac.za/rds and should be submitted to the Committee before the year has expired.

The Committee will then consider the continuation of the project for a further year (if necessary). Annually a number of projects may be selected randomly for an external audit.

Translation of the consent document to the language applicable to the study participants should be submitted.

Federal Wide Assurance Number: 00001372

Institutional Review Board (IRB) Number: IRB0005239

The Health Research Ethics Committee complies with the SA National Health Act No.61 2003 as it pertains to health research and the United States Code of

Federal Regulations Title 45 Part 46. This committee abides by the ethical norms and principles for research, established by the Declaration of Helsinki, the South African Medical Research Council Guidelines as well as the Guidelines for Ethical Research: Principles Structures and Processes 2004 (Department of Health).

Provincial and City of Cape Town Approval

Please note that for research at a primary or secondary healthcare facility permission must still be obtained from the relevant authorities (Western Cape Department of Health and/or City Health) to conduct the research as stated in the protocol. Contact persons are Ms Claudette Abrahams at Western Cape Department of Health (healthres@pgwc.gov.za Tel: +27 21 483 9907) and Dr Helene Visser at City Health (Helene.Visser@capetown.gov.za Tel: +27 21 400 3981).

Research that will be conducted at any tertiary academic institution requires approval from the relevant hospital manager. Ethics approval is required BEFORE approval can be obtained from these health authorities.

Ethics Reference #: S12/10/264

Title: A cross-sectional study on Intradialytic Hypertension at Four Haemodialysis Units in the Western Cape

We wish you the best as you conduct your research.

For standard HREC forms and documents please visit: www.sun.ac.za/rds

If you have any questions or need further assistance, please contact the HREC office at 0219389657.

Sincerely,

Franklin Weber

HREC Coordinator

Health Research Ethics Committee 1

Included Documents:

Protocol

Appendix

Synopsis

Declaration

CVs

Letter

Checklist

Consent

Application

Investigator Responsibilities

Protection of Human Research Participants

Some of the responsibilities investigators have when conducting research involving human participants are listed below:

1. **Conducting the Research.** You are responsible for making sure that the research is conducted according to the HREC approved research protocol. You are also responsible for the actions of all your co- investigators and research staff involved with this research.
2. **Participant Enrolment.** You may not recruit or enrol participants prior to the HREC approval date or after the expiration date of HREC approval. All recruitment materials for any form of media must be approved by the HREC prior to their use. If you need to recruit more participants than was noted in your HREC approval letter, you must submit an amendment requesting an increase in the number of participants.
3. **Informed Consent .**You are responsible for obtaining and documenting effective informed consent using only the HREC- approved consent documents, and for ensuring that no human participants are involved in research prior to obtaining their informed consent. Please give all participants copies of the signed informed consent documents. Keep the originals in your secured research files for at least fifteen (15) years.
4. **Continuing Review.** The HREC must review and approve all HREC- approved research protocols at intervals appropriate to the degree of risk but not less than once per year. There is no grace period. Prior to the date on which the HREC approval of the research expires, it is your responsibility to submit the continuing review report in a timely fashion to ensure a lapse in HREC approval does not occur. If HREC approval of your research lapses, you must stop new participant enrolment, and contact the HREC office immediately.
5. **Amendments and Changes.** If you wish to amend or change any aspect of your research (such as research design, interventions or procedures, number of participants, participant population, informed consent document, instruments, surveys or recruiting material), you must submit the amendment to the HREC for review using the current Amendment Form.

You may not initiate any amendments or changes to your research without first obtaining written HREC review and approval. The only exception is when it is necessary to eliminate apparent immediate hazards to participants and the HREC should be immediately informed of this necessity.

6. Adverse or Unanticipated Events. Any serious adverse events, participant complaints, and all unanticipated problems that involve risks to participants or others, as well as any research related injuries, occurring at this institution or at other performance sites must be reported to the HREC within five (5) days of discovery of the incident. You must also report any instances of serious or continuing problems, or non-compliance with the HRECs requirements for protecting human research participants.

The only exception to this policy is that the death of a research participant must be reported in accordance with the Stellenbosch University Health Research Ethics Committee Standard Operating Procedures [www.sun025.sun.ac.za/portal/page/portal/HealthSciences/English/Centres%20and%20Institutions/ResearchDevelopmentSupport/Ethics/Application package](http://www.sun025.sun.ac.za/portal/page/portal/HealthSciences/English/Centres%20and%20Institutions/ResearchDevelopmentSupport/Ethics/Application%20package). All reportable events should be submitted to the HREC using the Serious Adverse Event Report Form.

7. Research Record Keeping. You must keep the following research related records, at a minimum, in a secure location for a minimum of fifteen years: the HREC approved research protocol and all amendments; all informed consent documents; recruiting materials; continuing review reports; adverse or unanticipated events; and all correspondence from the HREC.
8. Reports to the MCC and Sponsor. When you submit the required annual report to the MCC or you submit required reports to your sponsor, you must provide a copy of that report to the HREC. You may submit the report at the time of continuing HREC review.
9. Provision of Emergency Medical Care. When a physician provides emergency medical care to a participant without prior HREC review and approval, to the extent permitted by law, such activities will not be recognised as research nor will the data obtained by any such activities should it be used in support of research.

10. Final reports. When you have completed (no further participant enrolment, interactions, interventions or data analysis) or stopped work on your research, you must submit a Final Report to the HREC.
11. On- Site Evaluations, MCC Inspections, or Audits. If you are notified that your research will be reviewed or audited by the MCC, the sponsor, any other external agency or any internal group, you must inform the HREC immediately of the impending audit/evaluation.

Appendix D: ClinicalTrials.gov registration

ClinicalTrials.gov

A service of the U.S. National Institutes of Health

Comment Period Extended to 3/23/2015 for Notice of Proposed Rulemaking (NPRM) for FDAAA 801 and NIH Draft Reporting Policy for NIH-Funded Trials

Trial record **1 of 1** for: NCT01916668

[Previous Study](#) | [Return to List](#) | [Next Study](#)

A Cross-sectional Study on Intradialytic Hypertension at Four Haemodialysis Units in the Western Cape

This study has been completed.

Sponsor:

University of Stellenbosch

Information provided by (Responsible Party):

Mogamat-Yazied Chothia, University of Stellenbosch

ClinicalTrials.gov Identifier:

NCT01916668

First received: February 1, 2013

Last updated: May 6, 2014

Last verified: May 2014

[History of Changes](#)

[Full Text View](#) [Tabular View](#) [No Study Results Posted](#) [Disclaimer](#)

[How to Read a Study Record](#)

► Purpose

Observational evidence indicates that intradialytic hypertension is associated with high morbidity & mortality. The investigators impression is that this problem may be more prevalent than initially suspected. To the investigators knowledge, there are no studies on intradialytic hypertension in the South African haemodialysis population.

Condition

Intradialytic Hypertension

Study Type: Observational

Study Design: Observational Model: Case Control

Time Perspective: Cross-Sectional

Official Title: A Cross-sectional Study on Intradialytic Hypertension at Four Haemodialysis Units in the Western Cape, South Africa

Resource links provided by NLM:

MedlinePlus related topics: [Dialysis](#) [High Blood Pressure](#)

[U.S. FDA Resources](#)

Further study details as provided by University of Stellenbosch:

Primary Outcome Measures:

- Prevalence of intradialytic hypertension at four haemodialysis units in the Western Cape [Time Frame: Up to 1 year] [Designated as safety issue: No]

Secondary Outcome Measures:

- Participants pre- and post hemodialysis bioimpedance measurements [Time Frame: Up to 1 year] [Designated as safety issue: No]

Enrollment: 200
Study Start Date: April 2013
Study Completion Date: May 2014
Primary Completion Date: April 2014 (Final data collection date for primary outcome measure)

Detailed Description:

Introduction

Intradialytic hypertension (IDH) is the paradoxical rise in blood pressure (BP) during or immediately after haemodialysis.

Nephrologists have yet to arrive at a standard definition of IDH. Definitions vary widely from systolic blood pressure rises of ≥ 10 mmHg, rise in mean arterial pressure (MAP) during dialysis > 15 mmHg to hypertension that appears resistant to ultrafiltration during or immediately after dialysis.¹ Depending on the definition used, the prevalence of IDH varies between 5-15%.

This phenomenon may appear trivial to the inexperienced doctor. However, IDH increases the risk of hospitalization and death as reported in the Crit-Line Intradialytic Monitoring Benefit Study (CLIMB) and United States Renal Data System (USRDS) haemodialysis study.

The pathogenesis of IDH is unclear. A number of factors have been implicated and probably work synergistically to promote the rise in BP. These include: subclinical volume overload, activation of the sympathetic and renin-angiotensin-aldosterone systems, endothelial dysfunction, sodium gain during dialysis, use of erythropoietin stimulating agents (ESAs) and removal of anti-hypertensive agents during dialysis.

The management of IDH relies heavily on control of sodium and fluid dynamics. There are no randomized controlled studies to guide management.

Objectives

Primary: Determine the prevalence of IDH at four haemodialysis units in the Western Cape

Secondary: To examine the association between IDH and the following potential risk factors:

Intradialytic weight gain, the presence and/or degree of fluid overload as assessed by bioimpedance monitoring, quantity and timing of anti-hypertensive drugs, ESA dose and route of administration, time-averaged sodium concentration, dialysate calcium concentrations and haemodialysis modality.

Methods

Study Design

A multicentre, cross-sectional study on chronic haemodialysis patients at four adult dialysis units in the Western Cape will be conducted. IDH will be defined as a rise of ≥ 10 mmHg in systolic blood pressure between pre- and post-dialysis in at least 4 out of six dialysis sessions. Patients screened as eligible for

inclusion in the study will be identified from haemodialysis charts by the primary investigator (PI). They will then be approached by the PI, who will try to obtain informed consent. Once informed consent has been obtained and no exclusion criteria are present, the patient will be enrolled. A study ID number will be allocated.

Using a standard operating protocol (SOP), weight, BP, pulse rate, bioimpedance, ultrafiltration rates and volumes will be determined before, hourly during dialysis and 30 minutes after completion of dialysis. Timing and use of antihypertensive drugs, ESA use, dialysis modality, intradialytic calcium and time averaged sodium levels will be determined. All data extracted will be captured onto a standardised data sheet.

► Eligibility

Ages Eligible for Study:	18 Years and older
Genders Eligible for Study:	Both
Accepts Healthy Volunteers:	No
Sampling Method:	Non-Probability Sample

Study Population

Chronic haemodialysis patients

Criteria

Inclusion Criteria:

- Males and females age > 18 years
- Ability to give informed consent

Exclusion Criteria:

- Inability to take blood pressure by routine methods in the upper limbs
- Inability to give informed consent
- Contraindications to bioimpedance monitoring (pre-existing implanted cardiac devices such as pacemakers, cardioverter defibrillators; amputees)
- Intercurrent acute illness

► Contacts and Locations

Choosing to participate in a study is an important personal decision. Talk with your doctor and family members or friends about deciding to join a study. To learn more about this study, you or your doctor may contact the study research staff using the Contacts provided below. For general information, see [Learn About Clinical Studies](#).

Please refer to this study by its ClinicalTrials.gov identifier: NCT01916668

Locations

South Africa

Tygerberg Academic Hospital
Cape Town, Western Cape, South Africa, 7505

Sponsors and Collaborators

University of Stellenbosch

Investigators

Principal Investigator: Mogamat-Yazied Dr.Chothia, FCP(SA) University of Stellenbosch

► **More Information**

No publications provided

Responsible Party: Mogamat-Yazied Chothia, Consultant Nephrologist, University of Stellenbosch

ClinicalTrials.gov Identifier: [NCT01916668](#) [History of Changes](#)

Other Study ID Numbers: S12/10/264

Study First Received: February 1, 2013

Last Updated: May 6, 2014

Health Authority: South Africa: Human Research Ethics Committee

Additional relevant MeSH terms:

Hypertension

Cardiovascular Diseases

Vascular Diseases

ClinicalTrials.gov processed this record on February 19, 2015

Appendix E: World Congress of Nephrology 2015, abstract submission.



Thank you very much for using the ISN World Congress of Nephrology 2015 abstract submission system. Your abstract has been successfully submitted to our database. Your abstract number is **WCN15-0447** Please keep in mind that **NO MORE CHANGES ARE POSSIBLE**. In case you have further questions or enquiries please contact ssrachova@theisn.org. Please find an overview of your saved abstract below:

Session type	Dialysis and transplantation
Topic	Haemodialysis
Consider for a Young Nephrologists Award	Best abstr. in clinical science-developing country
Presentation preference	Poster Presentation
Abstract title	INTRADIALYTIC HYPERTENSION IN CHRONIC HAEMODIALYSIS PATIENTS IN THE WESTERN CAPE, SOUTH AFRICA

S. Sebastian¹. C. Filmlalter². M.Y. Chothia¹.
¹Tygerberg Hospital, Cape Town, South Africa. ² Central University of Technology, Health Sciences, Bloemfontein, South Africa.

Introduction

Intradialytic hypertension (IDH), the paradoxical rise in blood pressure (BP) during haemodialysis, increases morbidity and mortality. The reported prevalence is 5-15%. The prevalence in South Africa is unknown. It is suggested that IDH may be due to subclinical fluid overload. We sought to determine the prevalence of IDH in our setting and studied its association with potential risk factors.

Methods

A cross-sectional study was conducted at four haemodialysis units in the Western Cape, South Africa. IDH cases were defined as an intradialytic rise >10mmHg in systolic BP in 4 of 6 consecutive dialysis sessions. Data were collected on demographics, fluid status using whole body bio-impedance, the haemodialysis procedure and medication.

Results

The prevalence of IDH was 28.4% (n=190). There was a trend toward 'overhydration' in the IDH group (2.6 L (95% CI 1.7- 3.4) vs. 1.8 L (95% CI 1.4-2.1); p=0.06) as measured by bio-impedance but no difference in mean ultrafiltration volume (2.4 L vs. 2.6 L; p=0.30). Mean age was similar (57.1 vs. 55.1 years; p=0.42), as was gender (males 53.7% vs. 59.5%, p=0.40), time-averaged sodium concentration (138.4 mM vs. 138.3 mM; p=0.72), dialysate calcium concentration (1.34 mM vs. 1.36 mM; p=0.46), weekly erythropoietin stimulating agent dose (6896 IU vs. 6352IU; p=0.38) in the IDH versus control groups respectively. A trend towards greater use of antihypertensive drugs was noted in the IDH group (2.5 drugs (95% CI 2.15-2.87) vs. 2.1 (95% CI 1.82-2.3); p=0.05). More participants in the IDH group received calcium channel blockers (54 vs. 36, p=0.03). There was no difference in the use of other antihypertensives.

Conclusions

The prevalence of IDH in our treatment centres is high. Subclinical fluid overload may contribute to IDH. The use of whole body bio-impedance identifies patients who may benefit from additional ultrafiltration.

Keywords

intradialytic hypertension
haemodialysis
whole body bio-impedance

Corporate sponsored research or other substantive relationships:
Consultation fee from Fresenius Medical Care.